



SFENG 1984 年 10 月 1 日 至 1984 年 12 月 31 日 止 的 年 度 审 计 报 告 附 件 中 的 有 关 内 容 均 与 本 公 司 无 关 且 不 能 作 为 本 公 司 的 财 务 报 告 的 有 关 内 容 的 有 关 内 容 。



品名	SF-L113
规格	100
数量	70000



L113-F1.4

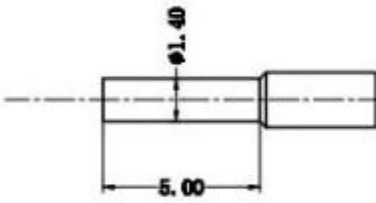

L113-H2.3

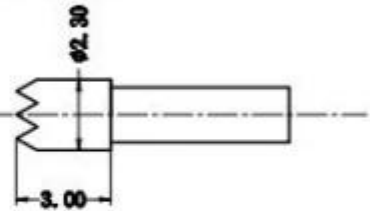

L113-H3.0

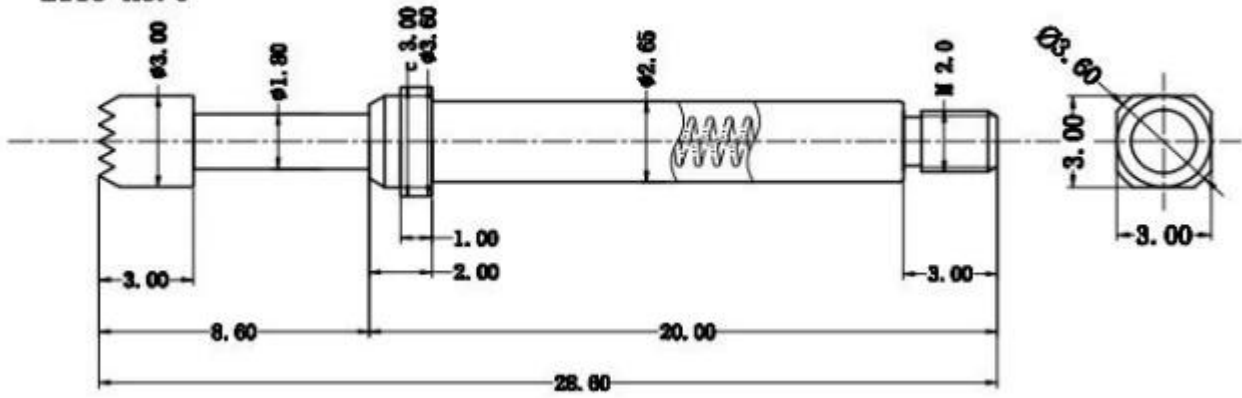

L113-套管

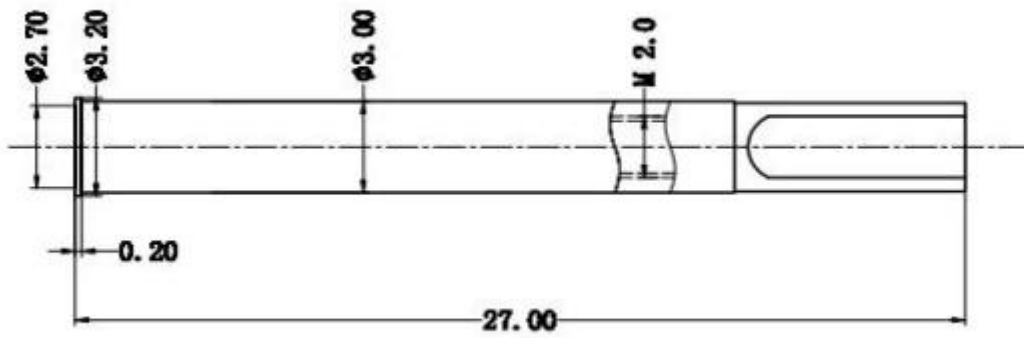

L112-JT1.0*2.0

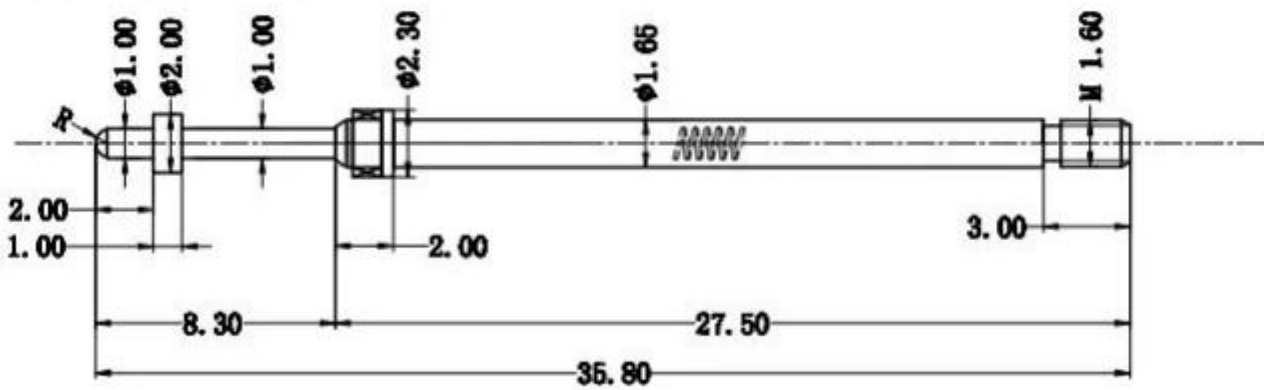

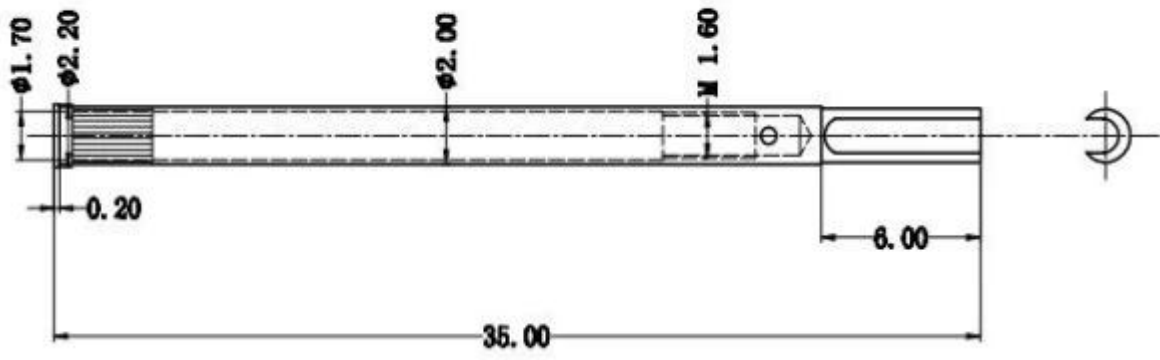

1. 24
2. OEM
- 3.
- 4.



1. PCB ICT FCT
2. Pogo pin
3. BGA
4. QZ VZ LM
- 5.
6. /
7. 30# OK POM





1. Raw material warehouse



2. Lathe workshop



3. Assemble workshop



4. Quality inspection



5. Finished products



6. Packing



1. Agilent current testing

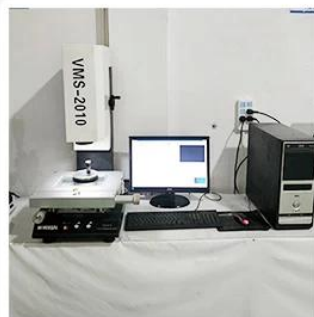

2. Quadratic element



3. Load Curve Meter



4. Bond Test



5. Life Fatigue Test



6. Microscope





Q1. □□□□□□

A1: □□□□□□□□□□□□□□□□□□□□

Q2. □□□□□□

A2: □□□□□□□□□□□□□□□□□□□□□□□□

Q3. □□□□□

A3: □□□□□□□□□□□□□□□□□□

Q4. □□□□□

A4: □□□□□□□□□□□□□□□□□□□□□□□□

Q5. □□□□□□□□□□

A5: [Placeholder]

Q6. [Placeholder]

A6: [Placeholder]

Q7. [Placeholder] **OEM** [Placeholder] **ODM** [Placeholder]

A7: [Placeholder] OEM/ODM [Placeholder]

Q8. [Placeholder]

A8: [Placeholder]