

□□□□

□□□□	SF5880
□□□□	3A
□□ □□	$\leq 50\text{m}\Omega$
□□□	4.0□□
□□□	$200\pm 20\%gf@$ □□ 4.0mm
□□□	100PCS
□□□□	100% T/T □□□
□□□□	5-10 □ □□ □□□

□□ □□

SF-P160

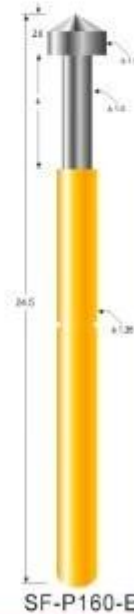
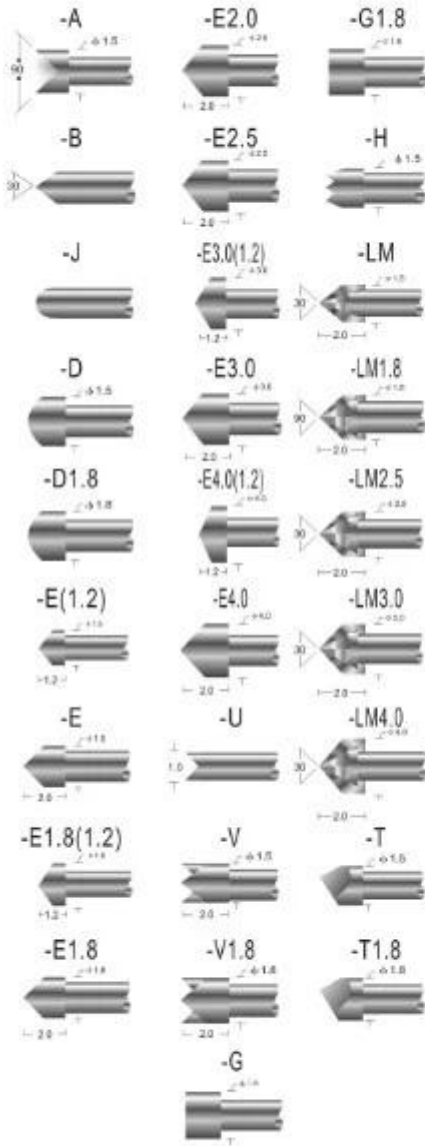

Probe specifications SF-P160(技术规格)

- Recommended minimum center(最小间距): 2.54mm(.1000 ")
- Mounting hole size(钻孔尺寸):
压克力: 1.70mm(.0670 ")
电木板、玻璃纤维板: 1.75mm(.0689 ")
- Full travel(行程): 4.0(.1575 ")
- Spring force(弹簧压力): 200g
- Materials and finishes(材料及涂饰):
Plunger: Be Cu, Rh plated; SK4, Rh plated
Barrel: Brass, Gold plated
Spring: Stainless steel
- Current ration(额定电流): 3A(安培)
- Contact resistance(接触电阻): 50mΩ (毫欧姆)

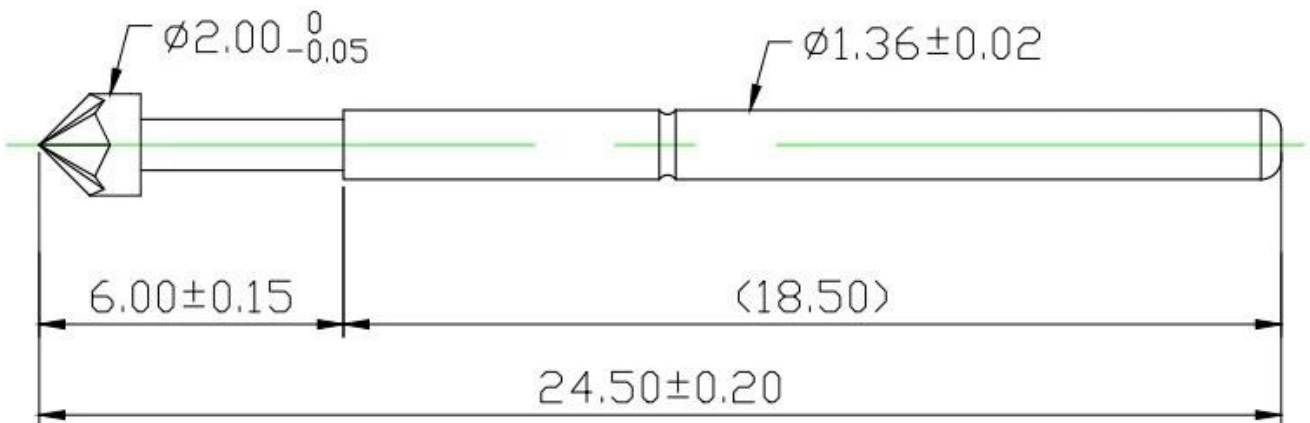



Production Flow (生产流程)

SFENG
The China's The World's



1. raw material warehouse



2. Lathe workshop



3. Assemble workshop



4. Quality inspection



5. Finished products



6. Packing



Measuring Equipment >

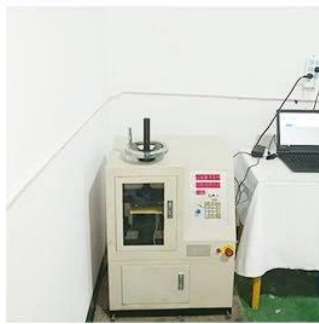
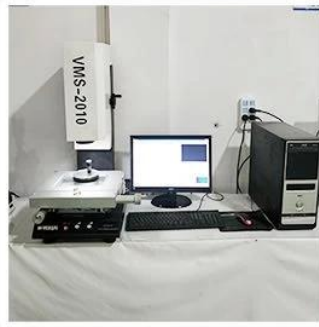
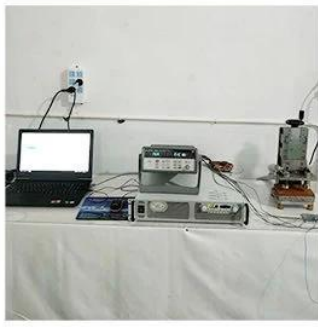

Measuring Equipment:

1. Agilent current testing;
2. Quadratic element measurement
3. Load Curve Meter
4. Bond Test
5. Life Fatigue Test





☐ ☐



Quality Management System Certificate of Approval

This is to certify that the QMS of

Suzhou Shengyifurui Electronic Technology Co.,Ltd

Unified Social Credit Code:91320506MA1NRNLF6N

Registration Address:Room 5277 Tianlong Building, No.378 Zhujiang Nan Road, Mudu Town,
Wuzhong District, Suzhou City

Business Address:Room 103 Units 2 Building 4, Xiangtihuayuan, No.567 Binhe Road, SND, Suzhou City

Has been assessed and found to meet the requirements of

GB/T 19001-2016/ISO 9001:2015

This certificate is valid for the following scope of operations:

Sales of test probes and related accessories

Date of Certificate Issue: Dec, 06, 2018

Certificate Valid Until: Dec, 05, 2021

Certificate Number: **QM291812020**

The validity of the registration will be continued only when the organisation pass the annual surveillance audit.

Check the validity of certificate at www.cnca.gov.cn or www.das-china.com

Surveillance Audits:

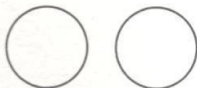

Authorized by:

Chief Executive



Shanghai DAS Certification Co., Ltd. , member of SN Registrars(Holdings) Ltd.

Add:505, Tower. 2, Guoson Center, No. 388, Zhongjiang Road, Shanghai, P.R.China, 200062

Tel: 0086-21-62773910 Fax:0086-21-62080319

Web:<http://www.das-china.com>

Email: info@das-china.com

UK Head Office:DAS Certification Limited (On Behalf of SN Registrars (Holdings) Limited)

ADD: Registration House, 22b Church Street, Rushden,

Northamptonshire, NN10 9YT, UK

Tel:+44(0)1933 381859

Email: info@dascertification.co.uk

Web: www.dascertification.co.uk

Company Number: 07659067



1. PCB ICT FCT
2. Pogo pin
3. BGA
4. LM QZ VZ
- 5.
6. &
7. POM

1. 24
2. OEM
- 3.
- 4.