

□□□□

□□	SFENG
□□□□	SF-PH15-H4.0
□□	SK4
□	□□
□□	□□□
□□□	150□
□□□□	5.0
□□□	100

□□□□

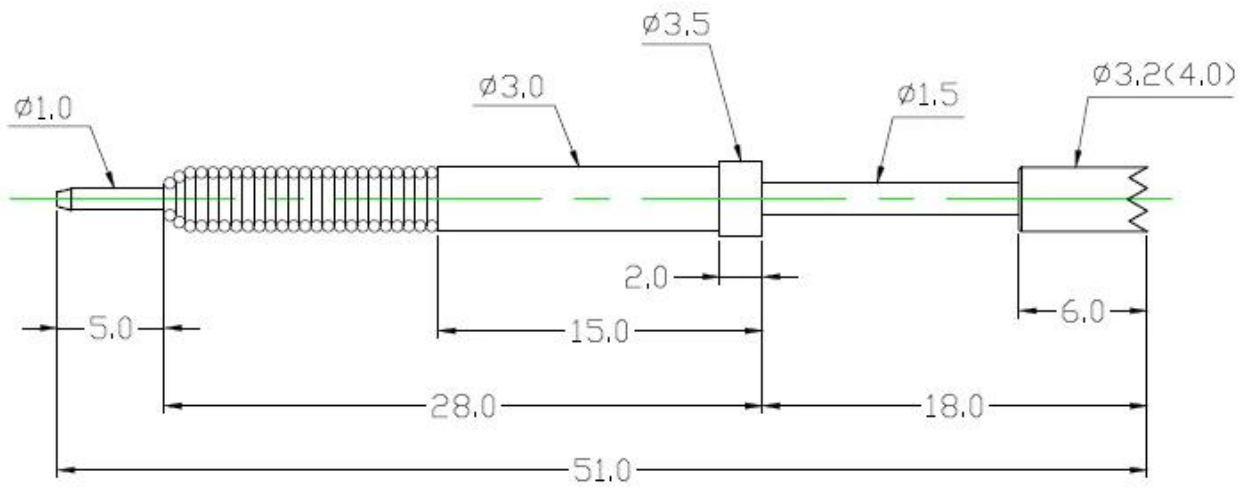



服務項目

1. 承接24小時緊急維修
2. 承接OEM
3. 承接各種精密加工
4. 承接各種精密組裝

服務範圍

承接 PCB、ICT、FCT 各種精密加工

Pogo pin 各種精密加工各種精密組裝各種精密組裝各種精密組裝

□□ BGA □□□□□□□□□□







□□□□□□□□□□QZ□VZ□□LM□□

□□□□□□□□□□□□□□

□□□□□/□□□

□□□□□□□□□30#OK□□□□□□POM□□□□□□

□□□□

Spring exhausted tester	DC power supply	Current resistance tester
		
Microscope	Tensile strength tester	Spring tester
		

□□□□

