

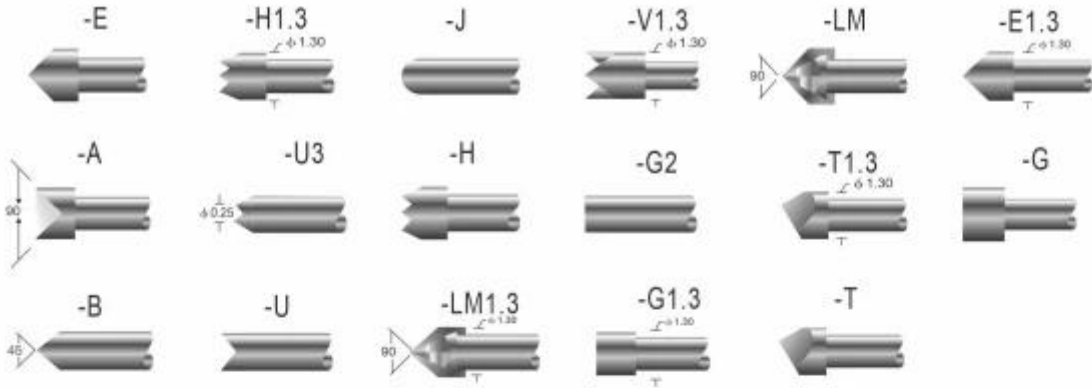

SFENG 1984 ()



技术规格 PROBE SPECIFICATIONS

Recommended minimum center 最小间距	1.0mm(.0394 ")
Mounting hole size 钻孔尺寸	0.75mm(.0295 ")
Full travel 行程	2.0(.0787 ")
Spring force 弹簧压力	80g(克)
Materials and finishes 材料及涂饰	Plunger:SK4, Ni or Au plated BeCu, Ni or Au plated Phosphor bronze, Ni or Au plated Barrel:Phosphor bronze, Au plated Spring:Stainless steel
Current ration 额定电流	1A(安培)
Contact resistance 接触电阻	50mΩ(毫欧姆)

Receptacle specifications
Materials and finishes: Phosphor bronze,Gold plated

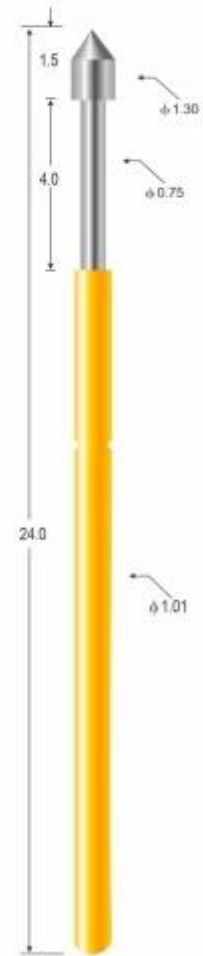

SP-P11-E

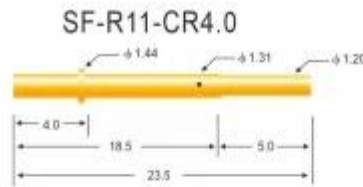
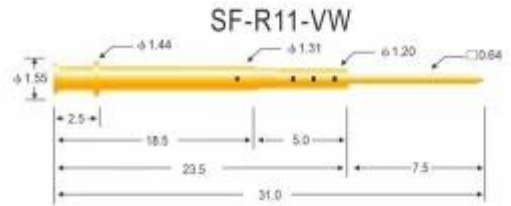
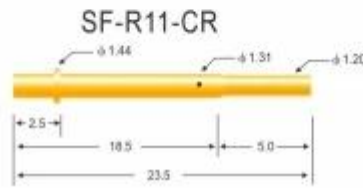
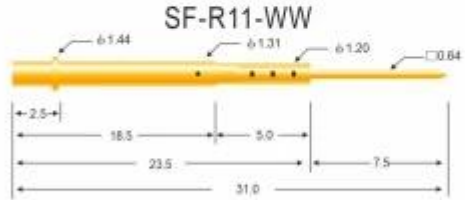
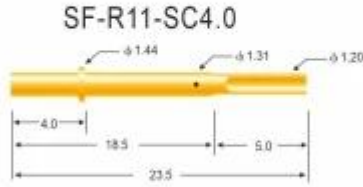
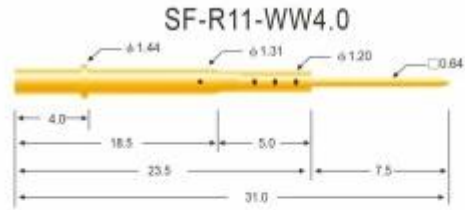
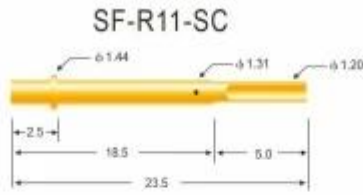

技术规格 PROBE SPECIFICATIONS

Recommended minimum center 最小间距	1.90mm(.0748 ")
Mounting hole size 钻孔尺寸	压克力: 1.35mm(.0532 ") 电木板、玻璃纤维板: 1.40mm(.0551 ")
Materials and finishes 材料及涂饰	Barrel: Brass, Au plated
Connections 接线形式	Crimp: R11-VCR, R11-CR, R11-CR4.0 Solder cup: R11-VSC, R11-SC, R11-SC4.0 Wire wrap: R11-VW, R11-WW, R11-WW4.0

Receptacle specifications
Materials and finishes: Phosphor bronze, Gold plated

□□□□

□□	SF-□11
□□□□□□	1□0mm□.0394"□
□□□□□	0.75mm□.0295"□
□□□□	2.0□.0787"□
□□□	80□
□□□□□	□□□SK4□□□ □□□□□□□□□□ □□□□□□□□□□
□□□□	1A



□□□□



1. Raw material warehouse



2. Lathe workshop



3. Assemble workshop



4. Quality inspection



5. Finished products



6. Packing

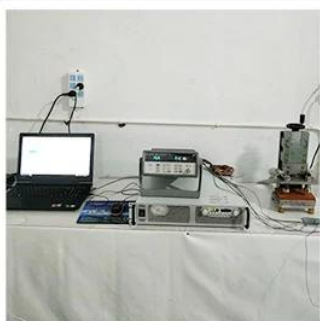

1. Agilent current testing

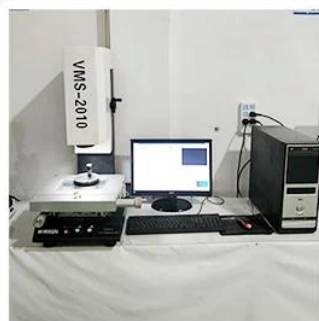

2. Quadratic element



3. Load Curve Meter



4. Bond Test



5. Life Fatigue Test



6. Microscope



Q1. 請說明

A1: 請說明

Q2. 請說明

A2: 請說明

Q3. 請說明

A3: 請說明

Q4. 請說明

A4: 請說明

Q5. 請說明

A5: 請說明

Q6. 請說明

A6: 請說明

Q7. 請說明 OEM 與 ODM 的區別

A7: 請說明 OEM / ODM 的區別。P 代表製造商，OEM 代表原始設備製造商，ODM 代表原始設計製造商。

Q8. 請說明

A8: 請說明

請說明

請說明 DHL、UPS、FedEx、TNT、EMS 的區別

請說明 Exwork、FOB、CNF、CIF 的區別



2023 ISO Certificate



Patent for Coaxial Structure



Patent for Honeycomb current probe









□□□□□



CIBF2021

苏州胜亿福睿电子科技有限公司
Suzhou Shengyifurui Electronic Technology Co., Ltd

No.3B013

