

Produktspezifikation

Marke	SFENG
Artikelnummer	SFM365 105 400 A8001
Plunger	Messing oder Becu, Gold oder Ni vernickelt
Lauf	Messing, Gold oder Ni vernickelt
Feder	SK4, Stahldraht
MOQ	100pcs
Vorlaufzeit	7 Arbeitstagen nach Erhalt der Zahlung

Produkt-Abbildung

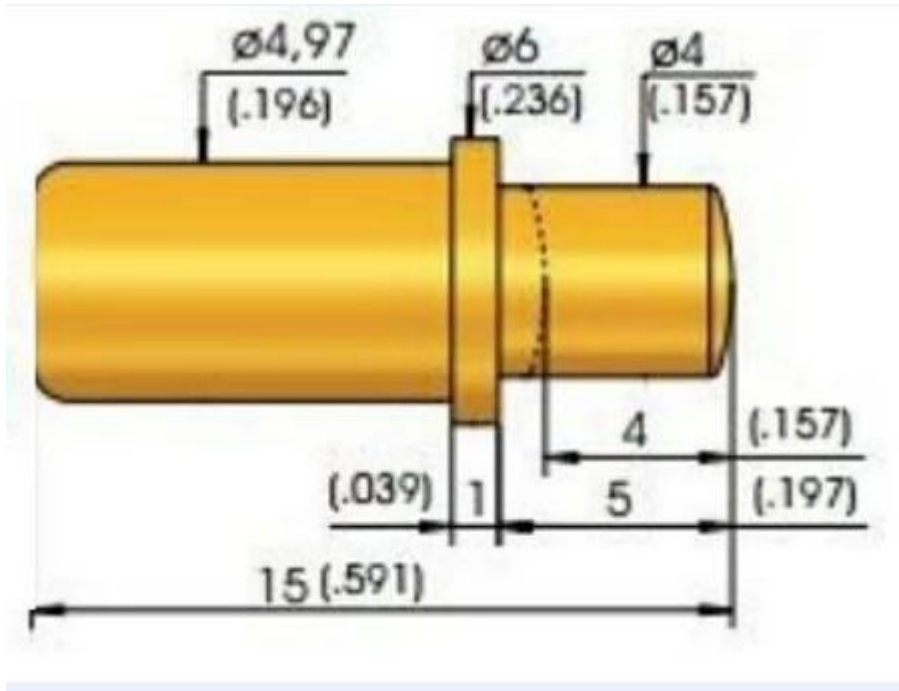









Unser Service

1. Reply Ihre Anfrage innerhalb von 24 Arbeitsstunden
2. Customized Entwurf ist vorhanden, OEM sind willkommen
3. Delivery die Sondenstifte für unsere Kunden auf der ganzen Erde mit Geschwindigkeit und Präzision
4. Provide den niedrigsten Preis mit Qualität zu unseren Kunden

Hauptartikel

- Federbelastete Pin (single) für PCB, ICT, FCT-Tests, etc;
- Pogo Stift (Stecker), um eine (usually temporary) Verbindung zwischen etablieren zwei Leiterplatten für charging, Ortung, Batterie, Semiconductor & amp; interconnect Applications;
- Doppel beendet probe for BGA & amp; semiconduction Prüfung;
- Universalstift ohne Feder, coating pin, LM Stift with QZ & amp; VZ series;
- Hochstrom Sonde, Switch-Sonde, Kapazität Nadel ...
- Terminal & amp; Aufnahme / Buchse;
- Sonstige nahe elektronischen compents, 30 # OK wire, Jig Schlösser, POM, Ironhinge, etc

Qualitätskontrolle

Spring exhausted tester	DC power supply	Current resistance tester
 A tall, white, industrial-grade cabinet with a glass-paned door and a control panel on the right side.	 A white, rectangular benchtop power supply unit with a black control panel featuring a red emergency stop button, several knobs, and a digital display.	 A white benchtop instrument with a large green digital display showing '8888' and a control knob on the right side.
Microscope	Tensile strength tester	Spring tester
 A white and black compound microscope with a camera attachment on top, mounted on a wooden desk.	 A blue and white mechanical testing machine with a vertical frame and a sample being held in place.	 A white mechanical testing machine with a digital display and a control panel, used for testing springs.

Verpackungs Bild

