

Produktspezifikation

Produktcode	SF-PPA1,7*7,95
Material	Lauf: Messing, Au auf Ni plattiert Kolben: Messing, Au auf Ni plattiert Frühling: SWP
Aktuelle Bewertung	3A
Voller Hub	2,0 mm

Produktzeichnung

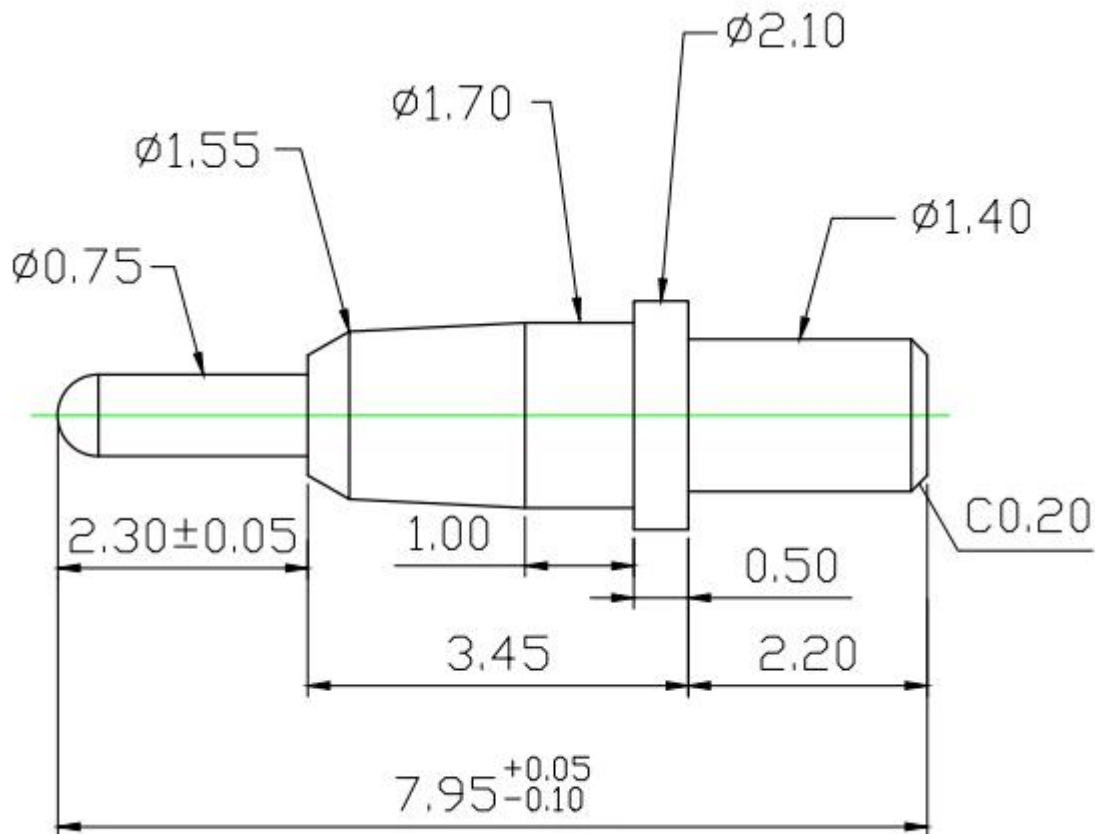

Unser Service

1. Wir können Ihre Anfrage innerhalb von 24 Arbeitsstunden beantworten.
2. Kundenspezifisches Design ist verfügbar und OEM sind willkommen.
3. Wir können die Prüfstifte schnell und präzise an unsere Kunden auf der ganzen Welt liefern.
4. Wir können unseren Kunden den niedrigsten Preis mit qualitativ hochwertigen Produkten bieten.

Hauptprodukte

Federbelasteter Stift (einzeln) für PCB-, ICT-, FCT-Tests usw.;

Pogo-Pin (Stecker) zum Herstellen einer Verbindung zwischen zwei Leiterplatten für Lade-, Ortungs-, Batterie-, Halbleiter- und Verbindungsanwendungen;

Doppelendige Sonde für BGA- und Halbleitertests;







Universalstift ohne Feder, Beschichtungsstift, LM-Stift mit QZ- und VZ-Serie;

Hochstromsonde, Schaltsonde, Kapazitätsnadel;

Anschluss und Buchse/Buchse;

Andere verwandte elektronische Komponenten, 30# OK-Kabel, Vorrichtungsschlösser, POM, Eisenscharniere usw

Qualitätskontrolle

Spring exhausted tester	DC power supply	Current resistance tester
		
Microscope	Tensile strength tester	Spring tester
		

Zertifizierung



Quality Management System Certificate of Approval

This is to certify that the QMS of

Suzhou Shengyifurui Electronic Technology Co.,Ltd

Unified Social Credit Code:91320506MA1NRNLF6N

Registration Address:Room 5277 Tianlong Building, No.378 Zhujiang Nan Road, Mudu Town,
Wuzhong District, Suzhou City

Business Address:Room 103 Units 2 Building 4, Xiangtihuayuan, No.567 Binhe Road, SND, Suzhou City

Has been assessed and found to meet the requirements of

GB/T 19001-2016/ISO 9001:2015

This certificate is valid for the following scope of operations:

Sales of test probes and related accessories

Date of Certificate Issue: Dec, 06, 2018

Certificate Valid Until: Dec, 05, 2021

Certificate Number: **QM291812020**

The validity of the registration will be continued only when the organisation pass the annual surveillance audit.
Check the validity of certificate at www.cnca.gov.cn or www.das-china.com

Surveillance Audits:

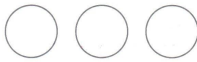

Authorized by:

Chief Executive



Shanghai DAS Certification Co., Ltd., member of SN Registrars(Holdings) Ltd.

Add:505, Tower. 2, Guoson Center, No. 388, Zhongjiang Road, Shanghai, P.R.China, 200062
Tel: 0086-21-62773910 Fax:0086-21-62080319
Web:<http://www.das-china.com>
Email: info@das-china.com
UK Head Office:DAS Certification Limited (On Behalf of SN Registrars (Holdings) Limited)
ADD: Registration House, 22b Church Street, Rushden, Northamptonshire, NN10 9YT, UK
Tel: +44(0)1933 381859
Email: info@dascertification.co.uk
Web: www.dascertification.co.uk
Company Number: 07659067



Verpackungsbild

