

Produktionsspezifikationen

Artikelnummer	SF5880
Aktuelle Ration	3A
Kontakt Widerstand	$\leq 50\text{m}\Omega$
Volle Fahrt	4,0 mm
Federkraft	200 \pm 20 % gf@ Last 4,0 mm
Mindestbestellmenge	100 Stück
Zahlungsfrist	100 % T/T vor dem Versand
Lieferzeit	5-10 Tage nach Erhalt der Zahlung

Produkt Bilder

SF-P160

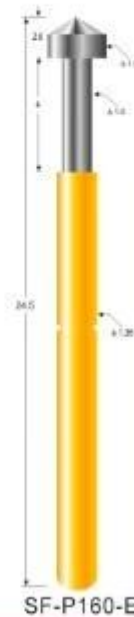
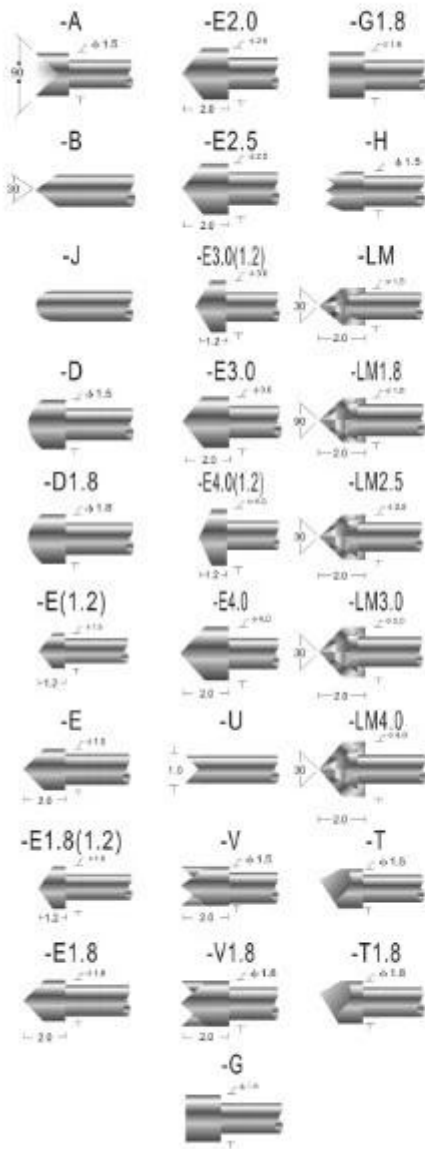

Probe specifications SF-P160(技术规格)

- Recommended minimum center(最小间距): 2.54mm(.1000 ")
- Mounting hole size(钻孔尺寸):
压克力: 1.70mm(.0670 ")
电木板、玻璃纤维板: 1.75mm(.0689 ")
- Full travel(行程): 4.0(.1575 ")
- Spring force(弹簧压力): 200g
- Materials and finishes(材料及涂饰):
Plunger: Be Cu, Rh plated; SK4, Rh plated
Barrel: Brass, Gold plated
Spring: Stainless steel
- Current ration(额定电流): 3A(安培)
- Contact resistance(接触电阻): 50mΩ (毫欧姆)

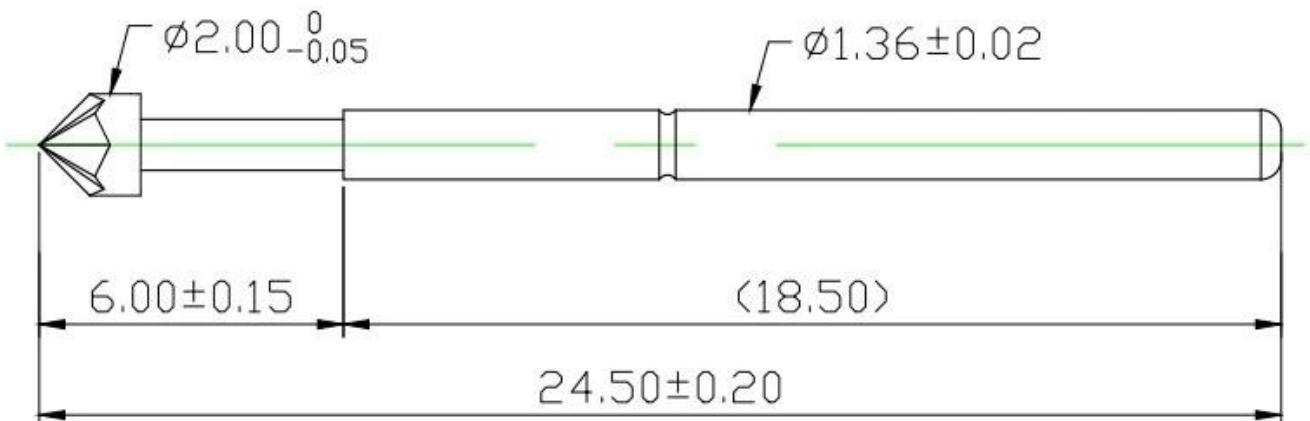

Produktion Fließen



Production Flow (生产流程)



1. raw material warehouse



2. Lathe workshop



3. Assemble workshop



4. Quality inspection



5. Finished products



6. Packing

Testen Ausrüstung

Measuring Equipment >

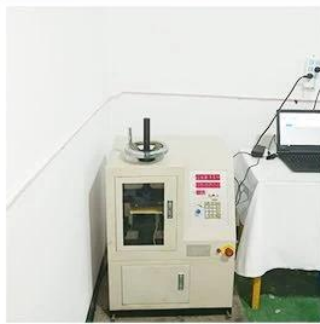
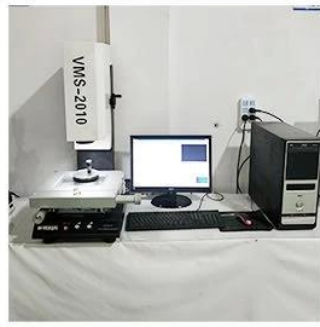
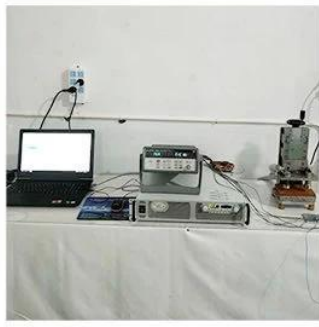

Measuring Equipment:

1. Agilent current testing;
2. Quadratic element measurement
3. Load Curve Meter
4. Bond Test
5. Life Fatigue Test

Verpackung



Qualitätszertifikat



Quality Management System Certificate of Approval

This is to certify that the QMS of

Suzhou Shengyifurui Electronic Technology Co.,Ltd

Unified Social Credit Code:91320506MA1NRNLF6N

Registration Address:Room 5277 Tianlong Building, No.378 Zhujiang Nan Road, Mudu Town,
Wuzhong District, Suzhou City

Business Address:Room 103 Units 2 Building 4, Xiangtihuayuan, No.567 Binhe Road, SND, Suzhou City

Has been assessed and found to meet the requirements of

GB/T 19001-2016/ISO 9001:2015

This certificate is valid for the following scope of operations:

Sales of test probes and related accessories

Date of Certificate Issue: Dec, 06, 2018

Certificate Valid Until: Dec, 05, 2021

Certificate Number: **QM291812020**

The validity of the registration will be continued only when the organisation pass the annual surveillance audit.

Check the validity of certificate at www.cnca.gov.cn or www.das-china.com

Surveillance Audits:

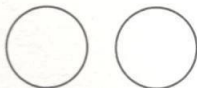

Authorized by:

Chief Executive



Shanghai DAS Certification Co., Ltd. , member of SN Registrars(Holdings) Ltd.

Add:505, Tower. 2, Guoson Center, No. 388, Zhongjiang Road, Shanghai, P.R.China, 200062

Tel: 0086-21-62773910 Fax:0086-21-62080319

Web:<http://www.das-china.com>

Email: info@das-china.com

UK Head Office: **DAS Certification Limited (On Behalf of SN Registrars (Holdings) Limited)**

ADD: Registration House, 22b Church Street, Rushden,

Northamptonshire, NN10 9YT, UK

Tel: +44(0)1933 381859

Email: info@dascertification.co.uk

Web: www.dascertification.co.uk

Company Number: 07659067



- 1.Federbelasteter Stift (einzeln) für Leiterplatten-, IKT-, FCT-Prüfungen usw.;
- 2.Pogo-Pin (Stecker) zum Herstellen einer Verbindung zwischen zwei Leiterplatten für Lade-, Lokalisierungs-, Batterie-, Halbleiter- und Verbindungsanwendungen;
3. Doppelendige Sonden für BGA- und Halbleitertests;
- 4.Universal Stift ohne Feder, Beschichtungstift, LM Stift mit QZ und VZ Serie;
- 5.Hochstromsonde, Schaltsonde, Kapazitätsnadel;
- 6.Terminal&Buchse/Buchse;
- 7.Andere verwandte elektronische Komponenten, Vorrichtungsschlösser, POM usw.

Was auch immer Sie möchten, kontaktieren Sie uns ohne Zögern und wir werden unser Bestes geben, um Ihre Anforderungen im Rahmen unserer Möglichkeiten zu erfüllen.

Unser Service

- 1.Wir können Ihre Anfrage innerhalb 24 Arbeitsstunden beantworten;
2. Kundenspezifisches Design ist verfügbar und OEM wird willkommen;
- 3.Wir können die Prüfstifte schnell und präzise an unsere Kunden auf der ganzen Welt liefern.
4. Wir können unseren Kunden den niedrigsten Preis mit qualitativ hochwertigen Produkten bieten.