

## Product Name: SF-pogo pin

### Material and finishes

Plunger: Be Cu, Rh plated

Barrel: Brass, Gold plated

Spring: Stainless steel

### Pictures

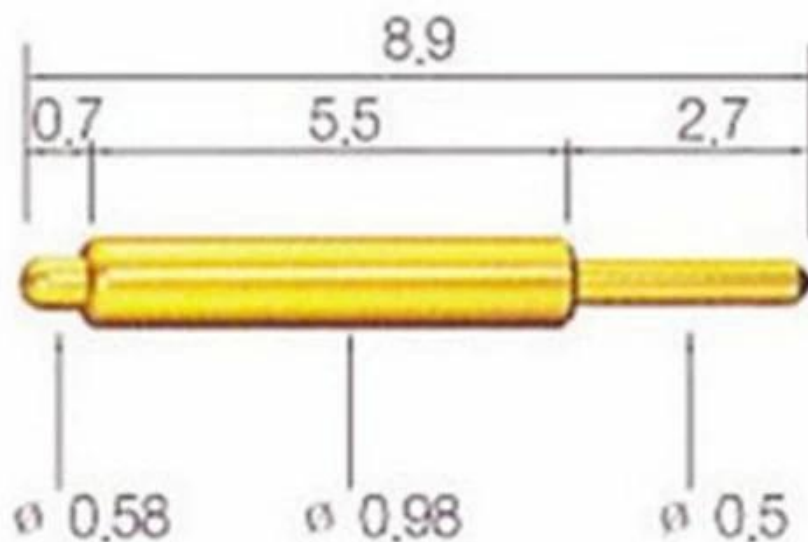

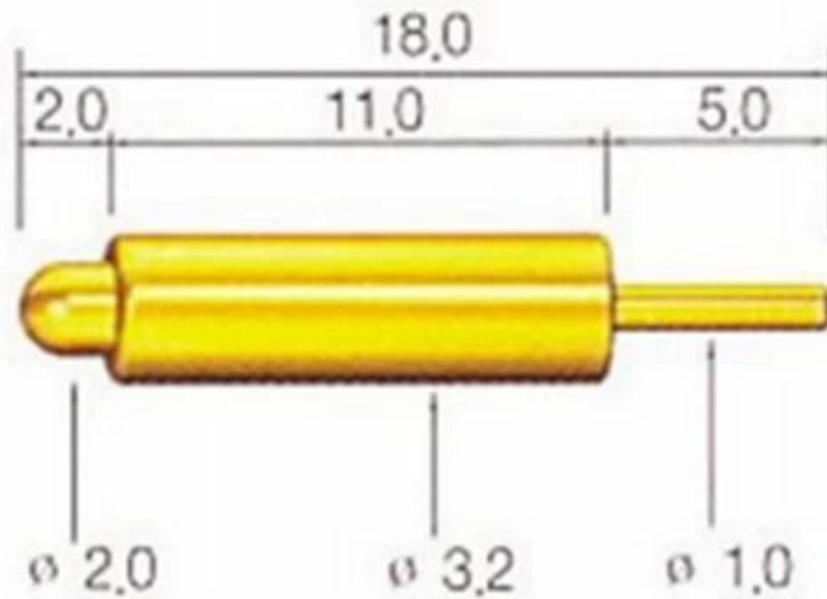

- Any tips,we could provide for you
- If you are interested in it,pls contact me

## **ShengFeng Probe**

Our company established in 1984,Shengfeng Probe,the register name of Suzhou Shengteng Electronic Co.,Ltd,specializing in the spring probe & the pogo pin &Terminal block with good quality,fast delivery and best service.

## **Our Advantages**

1. we have 30 years experience in probe pin and have ourself factory.

2. we provide free sample and have a testing department.







3. we could manufacture products as your request.

4. we guarantee best price and good service.

## **Our factory**



## **Our equipment**

Spring exhausted tester	DC power supply	Current resistance tester
		
Microscope	Tensile strength tester	Spring tester
		

**package**

