

Especificaciones del producto

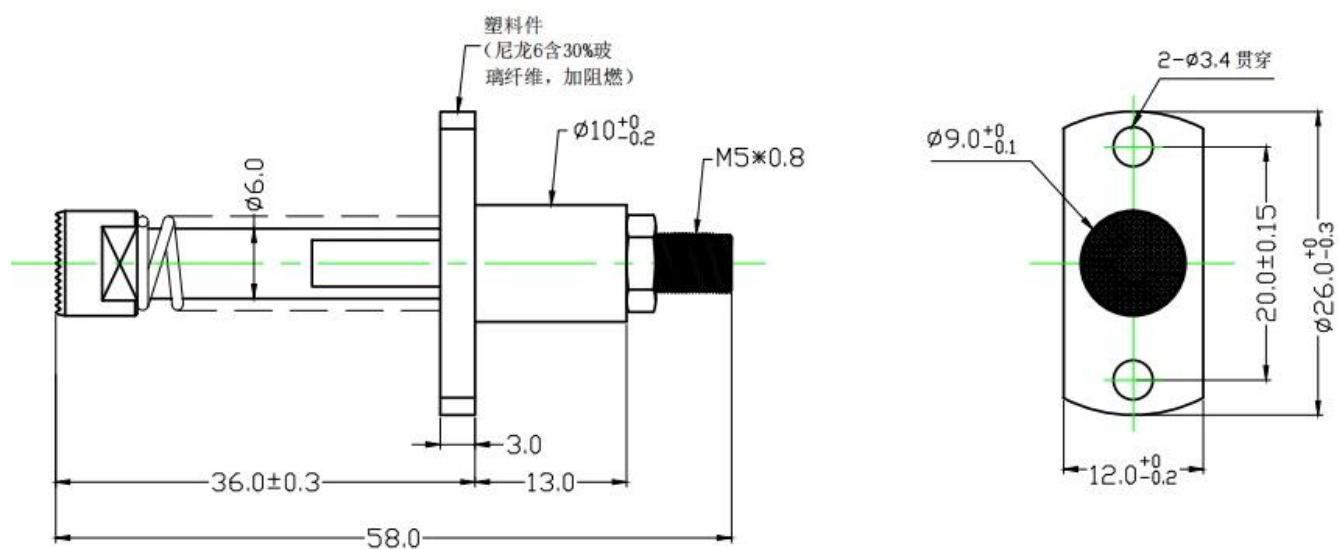

Modelo	Pin de sonda de corriente SF-30A (9,0*58,0)
Materiales	Latón
Tamaño	9,0*58mm
Actual clasificación	30A
Primavera fuerza	2500g

Imagen del producto

SFENG
The China's The World's



chinapogopinsupplier.com

Nuestro servicio

1. Podemos responder su consulta dentro de las 24 horas hábiles.
2. El diseño personalizado está disponible y los OEM son bienvenidos.
3. Podemos entregar los pines de sonda a nuestros clientes en todo el mundo con rapidez y precisión.
4. Podemos ofrecer el precio más bajo con productos de alta calidad a nuestro cliente .

Productos principales

Pasador con resorte (único) para pruebas de PCB, ICT, FCT, etc.

Pin Pogo (conector) para establecer la conexión entre dos placas de circuito impreso para aplicaciones de carga, localización, batería, semiconductores e interconexión;

Sonda de doble extremo para pruebas de BGA y semiconductores;

Pasador universal sin resorte, pasador de revestimiento, pasador LM con series QZ y VZ;

Sonda de alta corriente, sonda de interruptor, aguja de capacitancia;

Terminal y receptáculo/enchufe;

Otros componentes electrónicos relacionados, cable 30# OK, cerraduras Jig, POM, bisagra de hierro, etc.

Control de calidad







Spring exhausted tester	DC power supply	Current resistance tester
 A tall, white, industrial-grade cabinet with a glass door and a control panel on the right side.	 A white, rectangular power supply unit with a black top panel. It features a red emergency stop button, a power switch, and several output terminals.	 A white electronic device with a large green digital display showing '8888'. It has a 'HIGH BEAK' warning symbol and a control knob.
Microscope	Tensile strength tester	Spring tester
 A white and black compound microscope with a stage and objective lenses.	 A blue and white mechanical testing machine with a vertical column and a sample holder.	 A white mechanical testing machine with a digital display and a control panel.

Imagen de embalaje

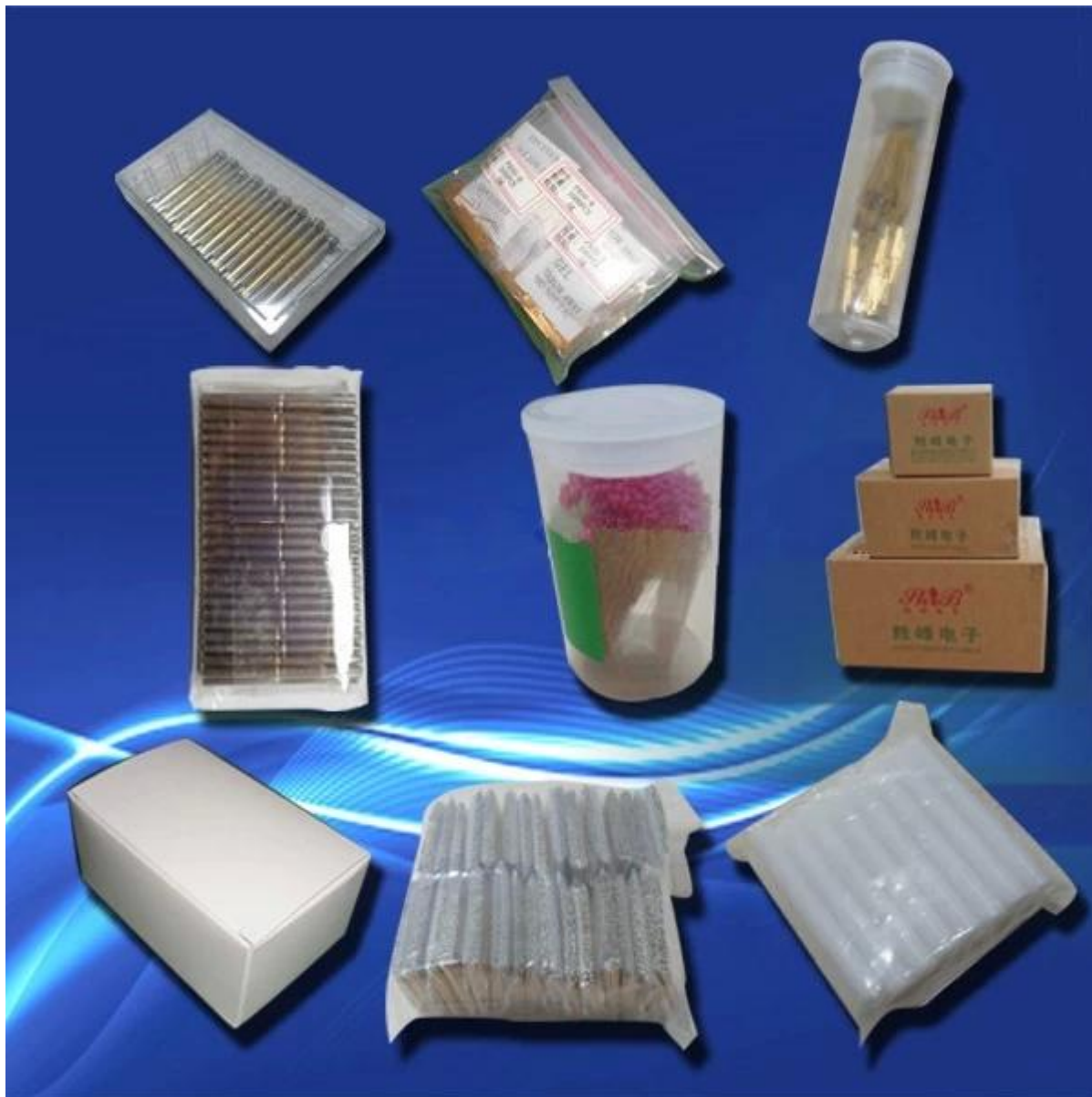

Imagen de fábrica

