

product name:SFENG probe pogo pin customed size SF-1.5*5.5-J

item	SF-PPA1.5*5.5-J
material	brass,Au plated,stainless steel
package	100PCS in a polybag
shipping	FEDEX,DHL
payment	T/T,Paypal
samples	can provide samples
lead time	within 7 working days after payment

pogo pin picture





pogo pin drawing

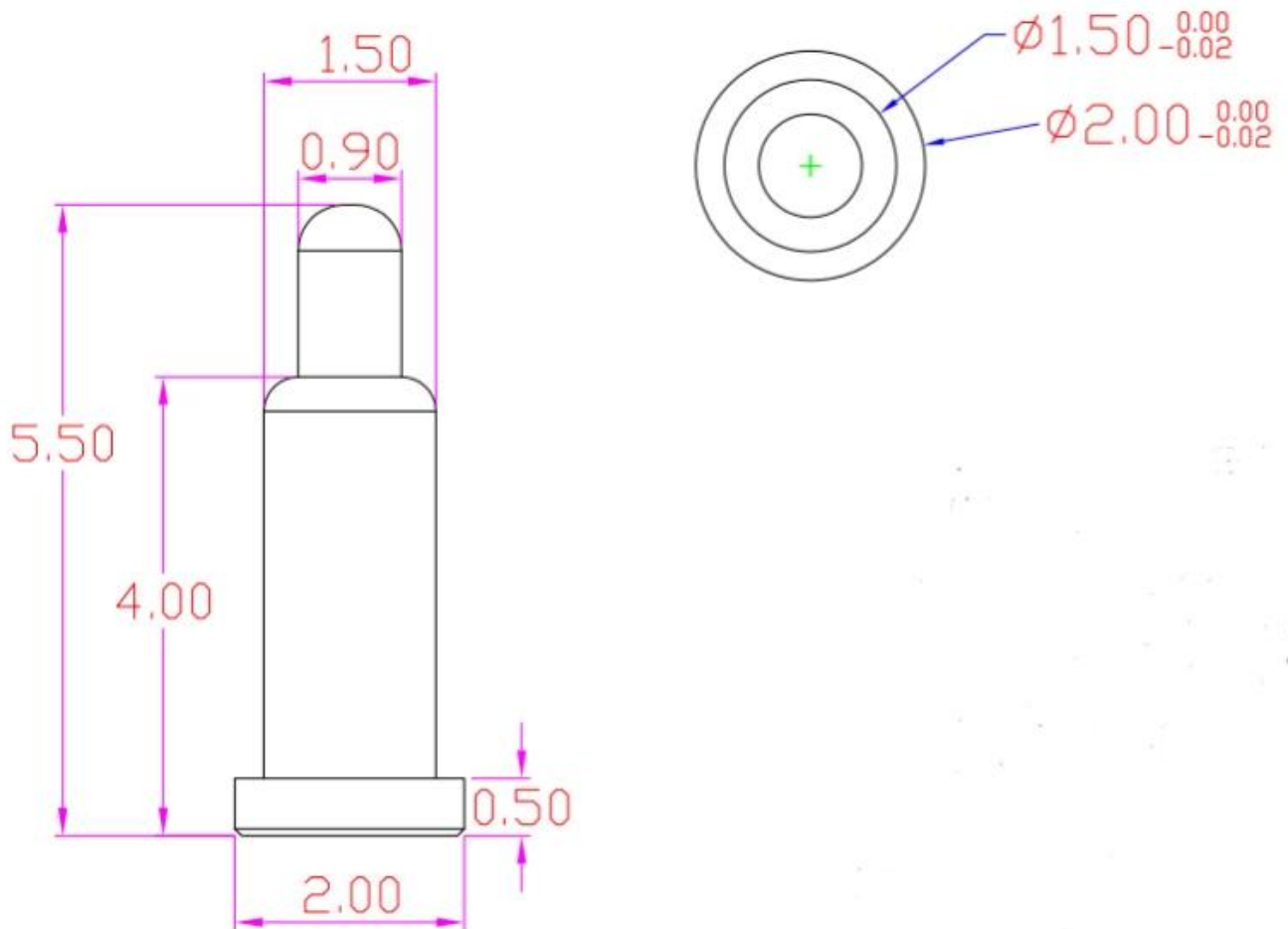

our factory



ShengFeng Probe

Our company established in 1984, Shengfeng Probe, the register name of Suzhou Shengteng Electronic Co., Ltd, specializing in the spring probe & the pogo pin & Terminal block with good quality, fast delivery and best

service.

Our service

1. We can reply your inquiry within 24 working hours.
2. Customized design is available and OEM are welcomed.
3. We can deliver the probe pins to our clients all over the world with speed and precision.
4. We can provide the lowest price with high quality product to our client .

Main Products

Spring loaded pin (single) for PCB, ICT, FCT testing etc;

Pogo pin (connector) to establish connection between two printed circuit boards for charging, locating, Battery, Semiconductor & Interconnect applications;

Double ended probe for BGA and Semiconductor testing;







Universal pin without spring, coating pin, LM pin with QZ and VZ series;

High current probe, Switch probe, Capacitance needle;

Terminal & receptacle /socket;

Other related electronic components, 30# OK wire, Jig locks, POM, Iron hinge etc

Equipment Control

Spring exhausted tester	DC power supply	Current resistance tester
		
Microscope	Tensile strength tester	Spring tester
		

package

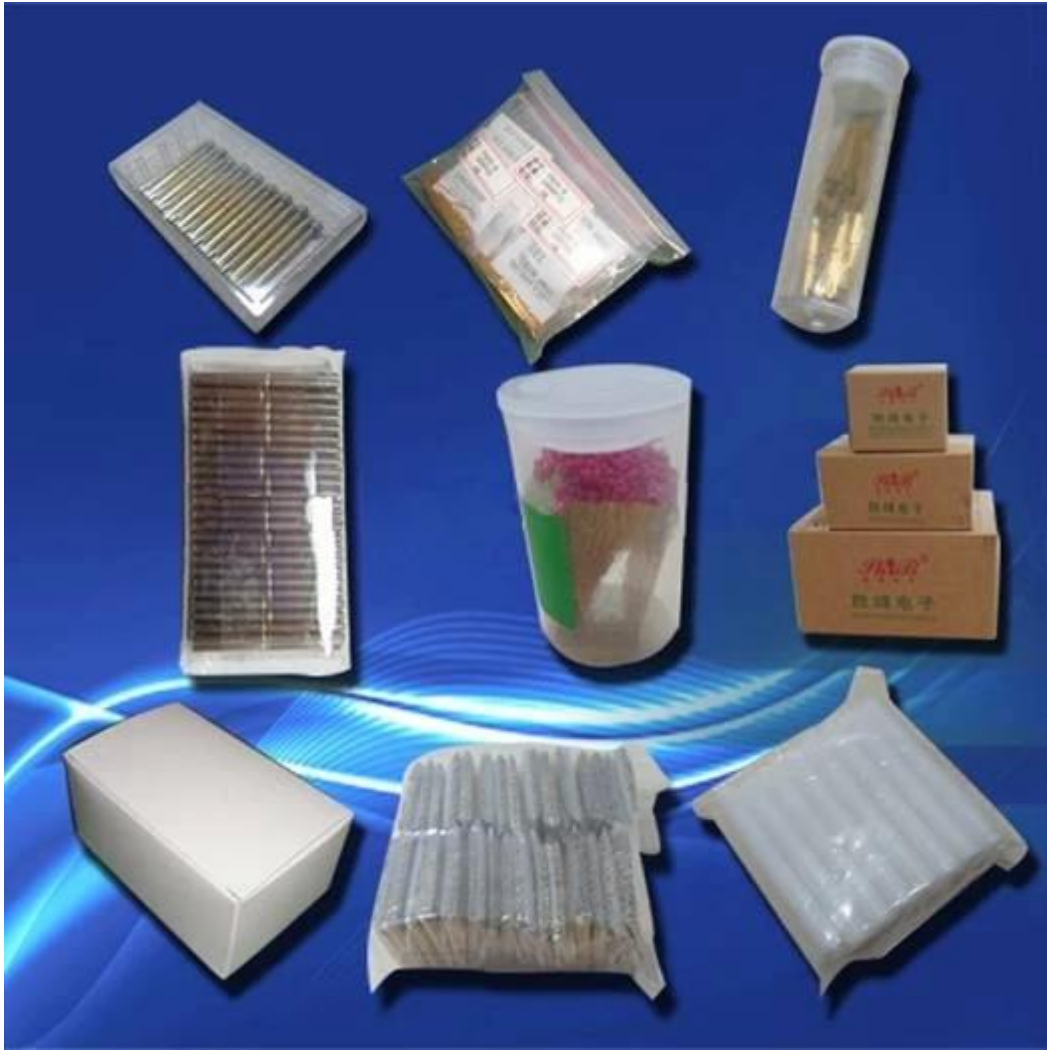

shipping



contact

Name	Anna
skype	sfprobe005
Wechat	cyl172839
cell	008613815297709
e-mail	anna@sf-probe.com