

## Spécification du produit

Marque	SFENG
Numéro d'article	SFM365 105 400 A8001
Piston	Laiton ou Becu, or ou plaquée Ni
Baril	Laiton, plaqué or ou Ni
Le printemps	SK4, fil de la musique
MOQ	100pcs
Délai de mise en œuvre	7 jours ouvrables après réception du paiement

## Image de produit

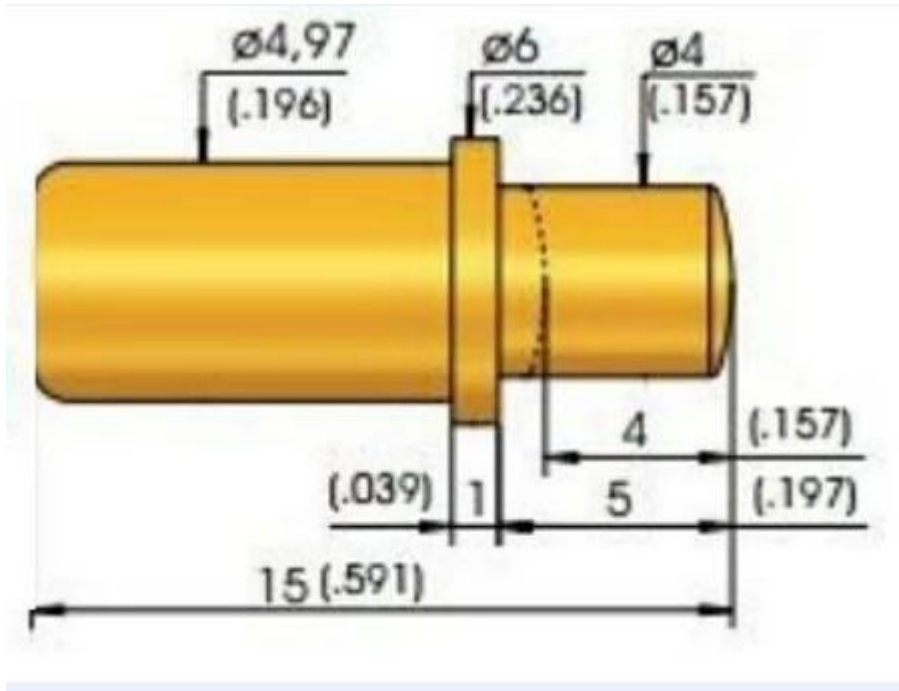



### Notre Service

1. Reply votre demande dans les 24 heures de travail
2. Customized conception est disponible, OEM sont bien accueillis
3. Delivery les broches de la sonde à nos clients partout dans le monde avec rapidité et précision
4. Fournir plus bas prix de haute qualité à nos clients

### Principaux produits

- Printemps chargé broches (unique) pour les PCB, les TIC, les tests FCT, etc;
- Pogo broches (connecteur) d'établir un (usually temporary) entre deux cartes de circuits imprimés pour Charing, la localisation, de la batterie, semi-conducteurs et amp; interconnect Applications;
- Terminé Double probef or BGA & amp; semiconudtion tests;
- Broche Universal sans ressort, coating pin, LM broche with QZ & amp; VZ series;
- Haut actuelle sonde, la sonde de l'interrupteur, l'aiguille de capacité ...
- Terminal & amp; réceptacle / prise;
- Autres connexes compents électroniques, 30 écluses # OKwire, sauteuses, POM, Ironhinge, etc.

Contrôle de qualité







Spring exhausted tester	DC power supply	Current resistance tester
 A tall, white, industrial-grade cabinet with a glass-paned door and a control panel on the right side.	 A white, rectangular benchtop power supply unit with a black control panel featuring a red emergency stop button, several knobs, and a digital display.	 A white benchtop device with a large green digital display showing '8888' and a control knob on the right side.
Microscope	Tensile strength tester	Spring tester
 A white and black compound microscope with a camera attachment on top, sitting on a wooden desk.	 A blue and white mechanical testing machine with a vertical frame and a sample being held in place.	 A white mechanical testing machine with a digital display and a control panel, used for testing springs.

Photo emballage

