

## 15A current probe with crown head tip probe SF-420 BY 4850

### **Product Specification**

Brand	SFENG
Item number	SF-420 by 4850
Plunger	Bronze
Barrel	Brass
Spring	stainless steel
Spring force	730g @ load 7.7mm rated stroke
Current Ration	15A
Plating	Gold plating
Pitch	No
Mounting hole size	No
MOQ	100pcs
Lead time	7 working days after receiving the payment

### **Product pictures**

# SFENG

The China's The World's





## Product drawing

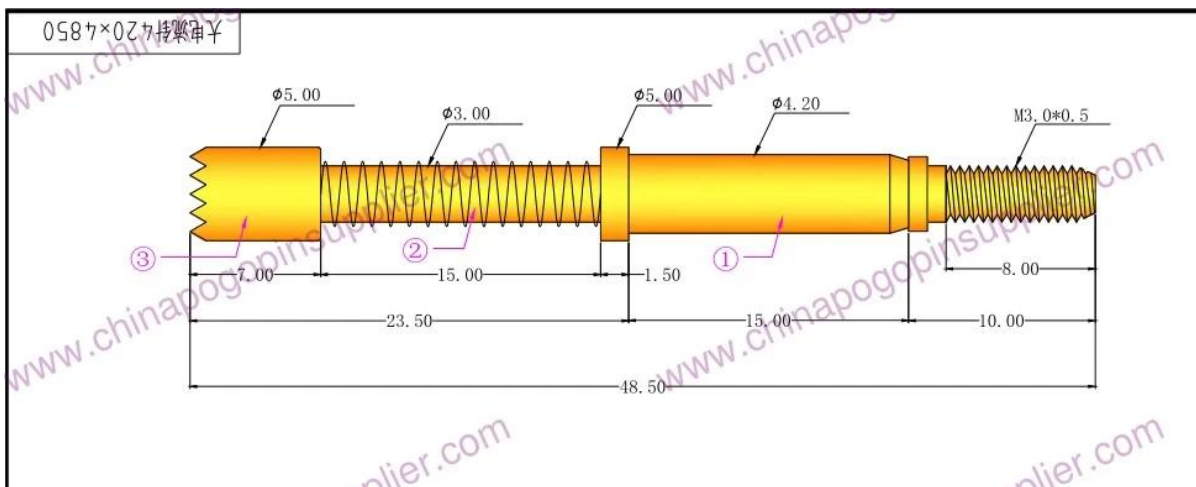

## our Service







1. We can reply your inquiry within 24 working hours.

- 2. Customized design is available and OEM are welcomed.
- 3. We can deliver the probe pins to our clients all over the world with speed and precision.
- 4. We can provide the lowest price with high quality product to our client .

**Main Products**

Spring loaded pin (single) for PCB, ICT, FCT testing etc;  
 Pogo pin (connector) to establish connection between two printed circuit boards for charging, locating, Battery, Semiconductor & Interconnect applications;  
 Double ended probe for BGA and Semiconductor testing;  
 Universal pin without spring, coating pin, LM pin with QZ and VZ series;  
 High current probe, Switch probe, Capacitance needle;  
 Terminal & receptacle /socket;  
 Other related electronic components, 30# OK wire, Jig locks, POM, Iron hinge etc

**Quality Control**

<p style="text-align: center;">Spring exhausted tester</p> 	<p style="text-align: center;">DC power supply</p> 	<p style="text-align: center;">Current resistance tester</p> 
<p style="text-align: center;">Microscope</p> 	<p style="text-align: center;">Tensile strength tester</p> 	<p style="text-align: center;">Spring tester</p> 

**Package**

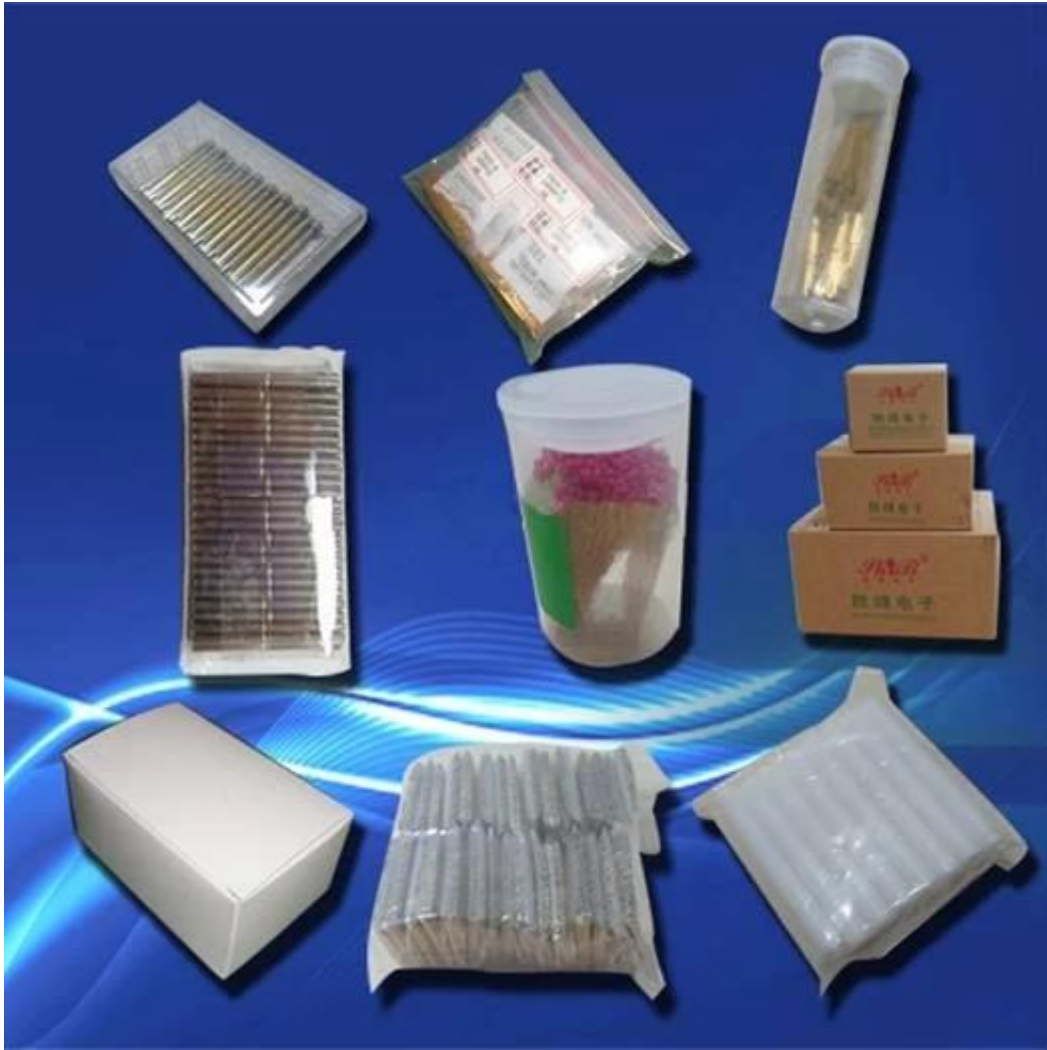

**Shipping:**

