

## About Us

SFENG was founded in 1984 and headquartered in Ningbo. It is a professional enterprise integrating research, development, production, and sales. ([china screw-in test pin manufacturers](#)) Products include in-circuit spring test probe, semiconductor spring test probe, battery charging pogo pin and the related accessories. Products are widely used in technology, automobiles, energy, telecommunications, medical, and other peripheral electronic products.

## Product Parameters

<b>Model Number</b>	<b>SF-L101</b>
MOQ	100pcs
Lead time	7 working days after receiving the payment

## Product Details

## 1. Screw Pin SF-L101-J0.5 & Receptacle L101

L101-J0.35

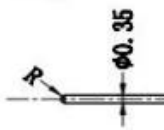

L101-J0.45

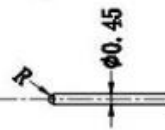

L101-J0.50

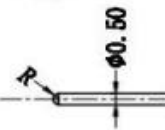

L101-D0.75

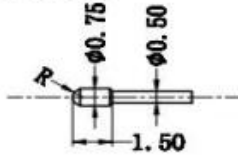

L101-H1.0

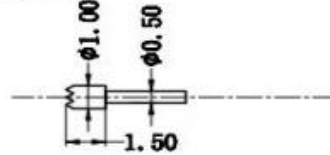

L101-D0.65

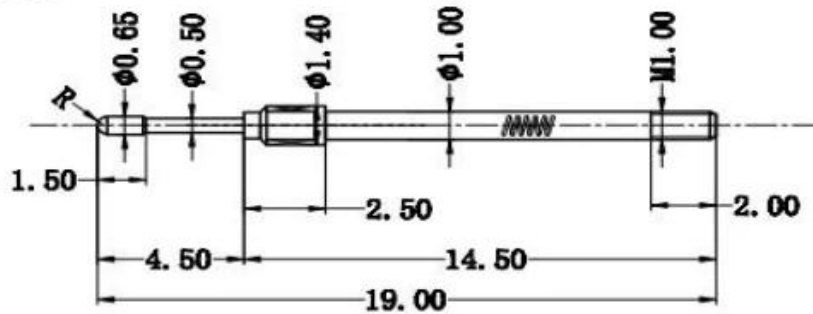

L101-套管

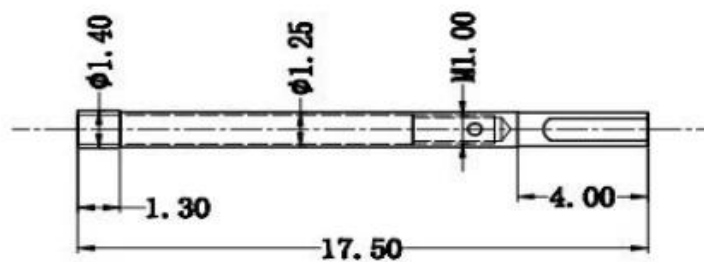

## Our Service

1. We can reply your inquiry within 24 working hours.
2. Customized design is available and OEM are welcomed.

3. We can deliver the probe pins to our clients all over the world with speed and precision.

4. We can provide the lowest price with high quality product to our client

## Mains products

1.Spring loaded pin (single) for PCB, ICT, FCT testing etc;

2.Pogo pin (connector) to establish connection between two printed circuit boards for charging, locating , Battery, Semiconductor & Interconnect applications;

3.Double ended probe for BGA and Semiconductor testing;

4.Universal pin without spring, coating pin, LM pin with QZ and VZ series;

5.High current probe, Switch probe, Capacitance needle;

6.Terminal & receptacle /socket;

7.Other related electronic components, 30# OK wire, Jig locks, POM, Iron hinge etc

**If you require custom items,please feel free to send us inquiry for more solutions!**

## Production Flow



1. Raw material warehouse



2. Lathe workshop



3. Assemble workshop



4. Quality inspection



5. Finished products



6. Packing

# Quality Control



1. Agilent current testing

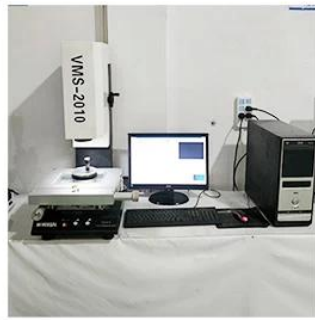

2. Quadratic element

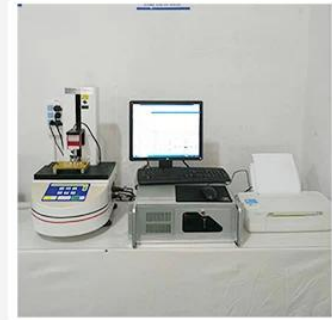

3. Load Curve Meter



4. Bond Test



5. Life Fatigue Test



6. Microscope

# Certifications



2023 ISO Certificate



Patent for Coaxial Structure



Patent for Honeycomb current probe

# Logistics

Sample order ship by DHL, UPS, FedEx, TNT, EMS etc

For mass order delivery, can be optional with terms of Exwork, FOB, CNF, CIF by air or by sea based on the buyer's forwarder or ours



## FAQ:

### Q1.Are you a manufacturer?

A1: Yes, we are an experienced manufacturer with our own molds and production lines.

### Q2.How about quality of products?

A2: Our technicians and QC teams test the products one by one using aging line, professional devices and instruments to ensure the quality for all products.

### Q3.How about price?

A3: We are a manufacturer and always offer our customers the most competitive prices.

**Q4.How to place an order?**

A4: Contact with online service, or sent email to us directly, we will reply to you with product price, specifications, packing etc. soon. Thank you.

**Q5.May I buy samples from you?**

A5: Yes! You are welcome to place sample order to test our superior quality and service, mixed samples are acceptable.

**Q6.Can I visit your factory?**

A6: Yes, welcome to visit our factory at your convenient time.

**Q7.How can I make OEM or ODM orders?**

A7: We have different print processing for different OEM/ODM orders. Please contact us with online service or send email to us directly.

**Q8. How should I pay for my orders?**

A8: You can pay by T/T, L/C at sight would be available for qualified bank and MOQ required for each order.