

## Pogo Pin SF-PA100-J1.0

Item	Pogo Pin SF-PA100-J1.0
Plunger	Ph with gold plated
Barrel	Brass with gold plated
Spring	SUS
Current ration	3A
Spring Force	300g
Package	100pcs in a polybag or as your request
Shipping time	within 7 working days

### pogo pin drawing

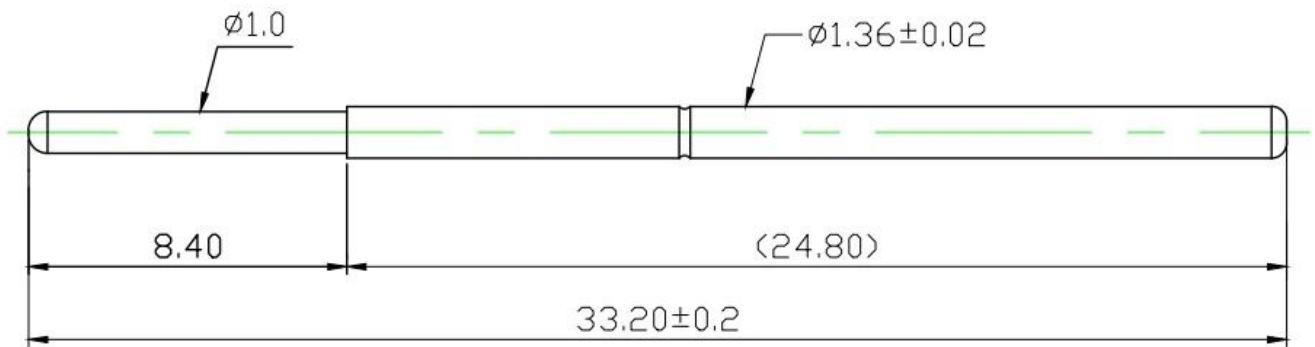

### pogo pin picture



**Related pogo pin**



SF-P071G-250

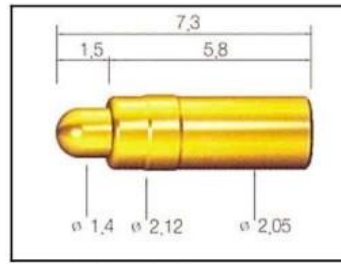

SF-P073G-205



SF-P089G-098



SF-P095G-250

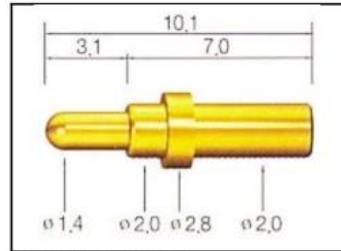

SF-P101G-200



SF-P105G-210

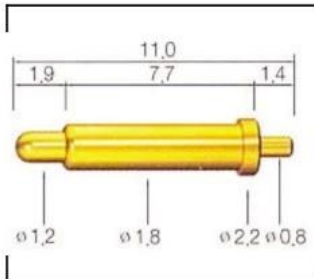

SF-P110G-180

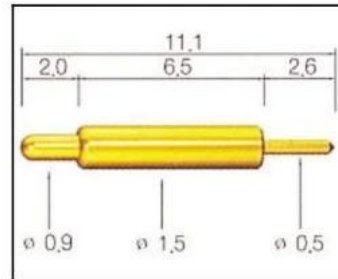

SF-111G-150



SF-120G-200

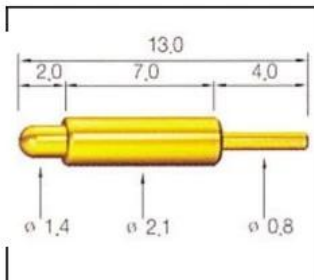

SF-130G-210

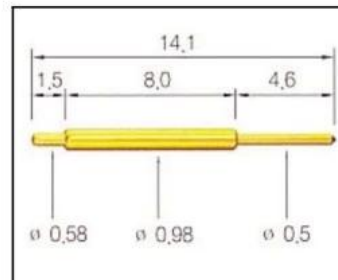

SF-141G-098



SF-154G-250



SF-155G-150



SF-167G-250



SF-169G-170



SF-174G-200



SF-P180G-210



SF-P180G-320

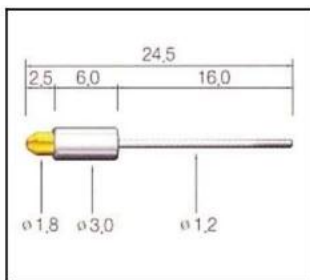

SF-245G-300



SF-P080G-170



SF-P085G-150

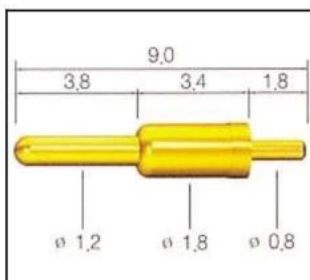

SF-P090G-180



SF-T125G-180



SF-T083G-260

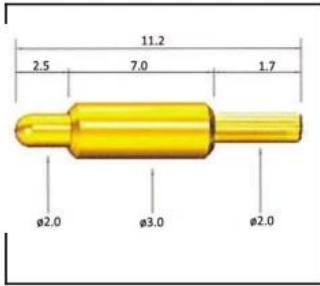

SF-112G-300



## Factory&company



## Our Service

1. We can reply your inquiry within 24 working hours.
2. Customized design is available and OEM are welcomed.
3. We can deliver the probe pins to our clients all over the world with speed and precision.
4. We can provide the lowest price with high quality product to our client.

## Main Products

Spring loaded pin (single) for PCB, ICT, FCT testing etc;

Pogo pin (connector) to establish connection between two printed circuit boards for charging,

locating, Battery, Semiconductor & Interconnect applications;

BGA test probe pin and Semiconductor testing;

Universal pin without spring, coating pin, LM pin with QZ and VZ series;

High current probe, Switch probe, Capacitance needle;

Terminal & receptacle /socket;

Other related electronic components, 30# OK wire, Jig locks, POM, Iron hinge etc

## Equipment control

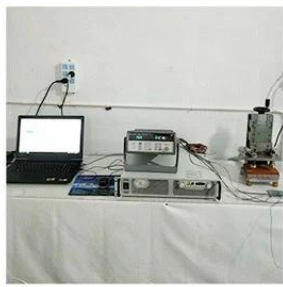

1. Agilent current testing

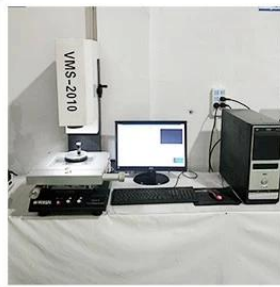

2. Quadratic element



3. Load Curve Meter



4. Bond Test



5. Life Fatigue Test



6. Microscope

## Package & Shipping



Standard products will be delivered out within 3 days. Customized products will be sent out within 15 days.

