

Product Specification

Brand	SFENG
Item number	SF-HCP10*70
Plunger	Brass
Barrel	Brass
Spring	SUS
Spring Force	customzied
Full Travel	customzied
Current Ration	30A
MOQ	100 pcs
Lead time	7 working days after receiving the payment

Product Picture

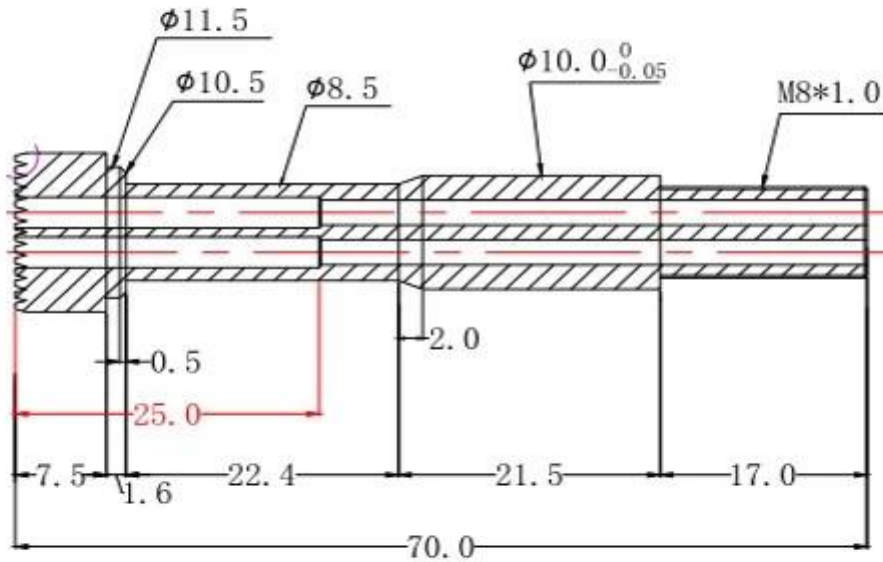



Our Service

1. We can reply your inquiry within 24 working hours.
2. Customized design is available and OEM are welcomed.
3. We can deliver the probe pins to our clients all over the world with speed and precision.
4. We can provide the lowest price with high quality product to our client .

Main Products

Spring loaded pin (single) for PCB, ICT, FCT testing etc;

Pogo pin (connector) to establish connection between two printed circuit boards for charging, locating, Battery, Semiconductor & Interconnect applications;

Double ended probe for BGA and Semiconductor testing;







Universal pin without spring, coating pin, LM pin with QZ and VZ series;

High current probe, Switch probe, Capacitance needle;

Terminal & receptacle /socket;

Other related electronic components, 30# OK wire, Jig locks, POM, Iron hinge etc

Quality Control

Spring exhausted tester	DC power supply	Current resistance tester
 A large, white, industrial-grade machine with a glass door and a control panel on the right side.	 A white, rectangular device with a black front panel. It features a red power switch, several knobs, and output terminals. The brand name 'YoRi' is visible on the top left.	 A white, rectangular device with a large green digital display showing '8888'. It has a control knob and a warning symbol on the right side.
Microscope	Tensile strength tester	Spring tester
 A white and black compound microscope with a stage and objective lenses.	 A blue and white machine used for testing the tensile strength of materials, featuring a vertical column and a sample holder.	 A white and blue machine used for testing springs, with a vertical column and a digital display on the front.

Packing Picture

