

Product Specification

Item Code	SF-PV1-H-H
Material	Plunger: Becu Barrel: Brass, PEEK Spring: SUS304
Spring force	550g
Recommended Stroke	6.0mm
Current Ration	30A
Resistance	□10mΩ

Product Drawing

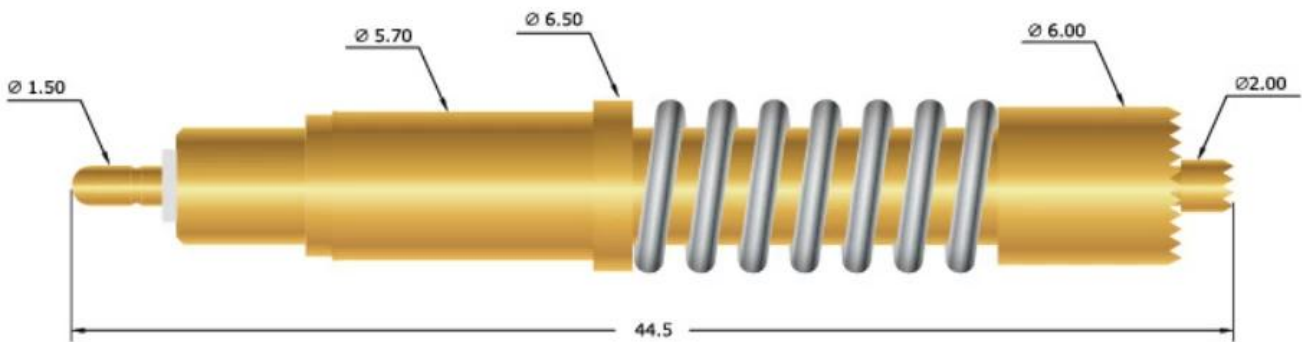

Our Service







1. Reply your inquiry within 24 working hours
2. Customized design is available, OEM are welcomed
3. Delivery the probe pins to our clients all over the world with speed and precision
4. Provide the lowest price with high quality to our client

Main Products

- Spring loaded pin(single) for PCB,ICT,FCT testing,etc;
- Pogo pin(connector) to establish a(usually temporary)connection between two printed circuit boards for charging, locating, Battery, Semiconductor & interconnect Applications;
- Double ended probe for BGA & semiconductor testing;

- Universal pin without spring,coatingpin,LM pin withQZ&VZseries;
- High current probe,Switch probe,Capacitance needle...
- Terminal&receptacle/socket;
- Other related electronic compents,30#OKwire,Jig locks,POM,Ironhinge,etc

Quality Control

Spring exhausted tester	DC power supply	Current resistance tester
		
Microscope	Tensile strength tester	Spring tester
		

Packing Picture

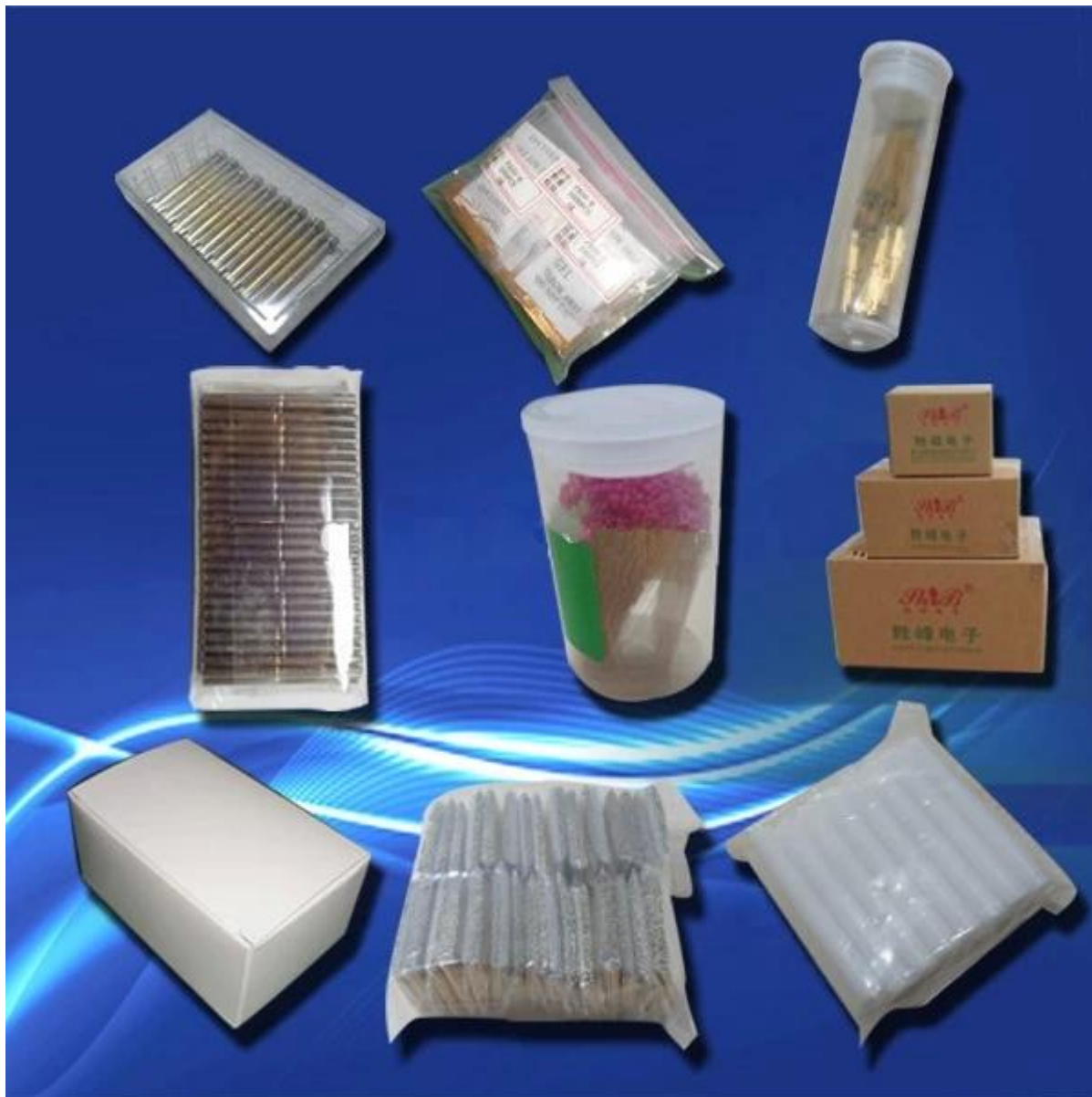

Factory Image

