

Product Specification

Brand	SFENG
Item number	SF-PH15-H3.2
Plunger	SK4
Barrel	Becu
Spring	SUS
Spring Force	150g
Full Travel	5.0
MOQ	100

Product Picture

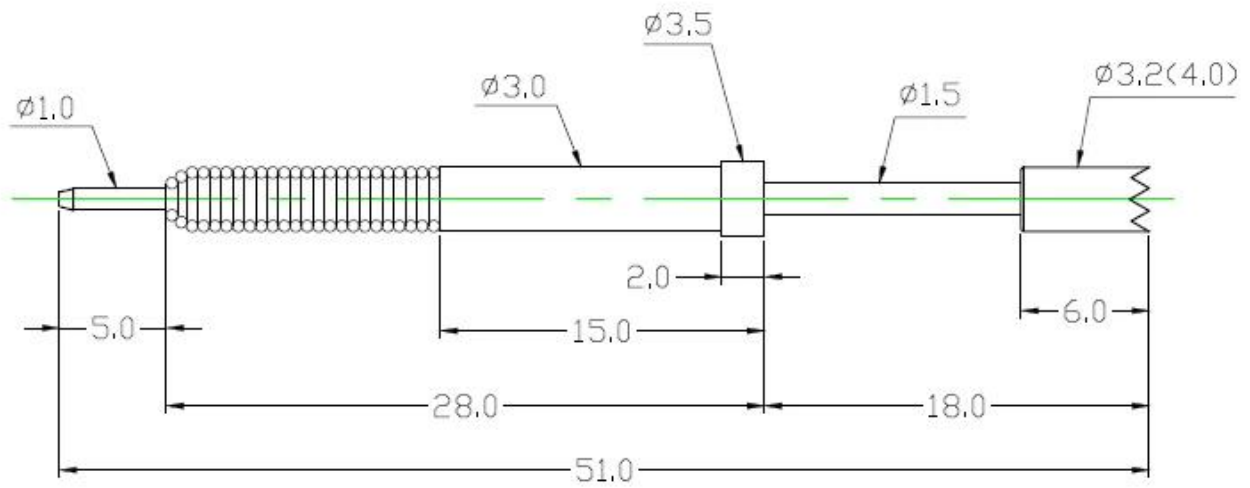



Our Service

1. We can reply your inquiry within 24 working hours.
2. Customized design is available and OEM are welcomed.
3. We can deliver the probe pins to our clients all over the world with speed and precision.
4. We can provide the lowest price with high quality product to our client .

Main Products

Spring loaded pin (single) for PCB, ICT, FCT testing etc;

Pogo pin (connector) to establish connection between two printed circuit boards for charging, locating, Batt

ery, Semiconductor & Interconnect applications;

Double ended probe for BGA and Semiconductor testing;







Universal pin without spring, coating pin, LM pin with QZ and VZ series;

High current probe, Switch probe, Capacitance needle;

Terminal & receptacle /socket;

Other related electronic components, 30# OK wire, Jig locks, POM, Iron hinge etc

Quality Control

Spring exhausted tester	DC power supply	Current resistance tester
 A tall, white, cabinet-style machine with a glass door on the upper half and a control panel on the right side.	 A white, rectangular device with a black top section. The front panel features a red power switch, several knobs, and output terminals. The brand name 'YoRi' is visible on the top left.	 A white, rectangular device with a large green digital display showing '8888'. It has a control knob and a warning symbol on the right side.
Microscope	Tensile strength tester	Spring tester
 A white and black compound microscope with a large objective lens and a stage.	 A blue and white mechanical testing machine with a vertical column and a sample holder.	 A white mechanical testing machine with a digital display and a control panel, used for testing springs.

Packing Picture

