

10A current rasion gold plated sring current pogo pin  
8.0\*22mm

<b>Item</b>	SF-PPA8.0*22MM
<b>Plunger</b>	Brass with gold plated
<b>Barrel</b>	Brass with gold plated
<b>Spring</b>	Stainless steel or music wire
<b>Current rasion</b>	10A
<b>MOQ</b>	100pcs
<b>Package</b>	plasic box, carton box

pogo pin drawing:

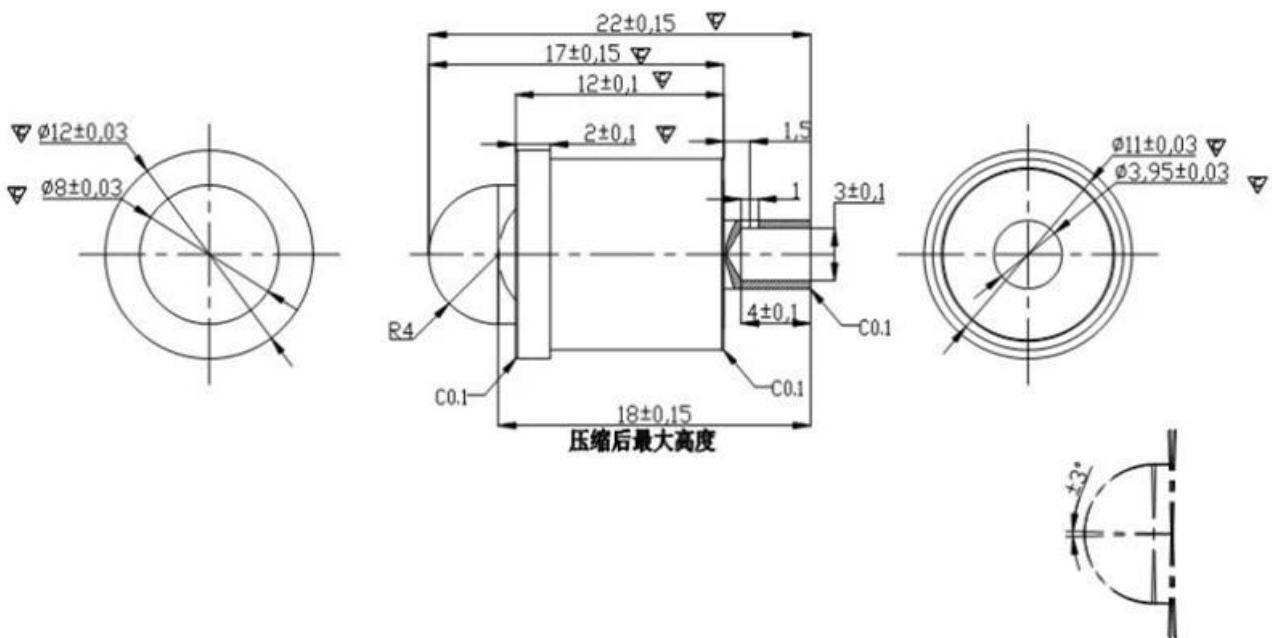

Pogo pin picture



Pogo pin (connector) to establish connection between two printed circuit boards for charging,

locating, Battery, Semiconductor & Interconnect applications;

BGA test probe pin and Semiconductor testing;







Universal pin without spring, coating pin, LM pin with QZ and VZ series;

High current probe, Switch probe, Capacitance needle;

Terminal & receptacle /socket;

Other related electronic components, 30# OK wire, Jig locks, POM, Iron hinge etc

## Equipment control

Spring exhausted tester	DC power supply	Current resistance tester
		
Microscope	Tensile strength tester	Spring tester
		

## Package

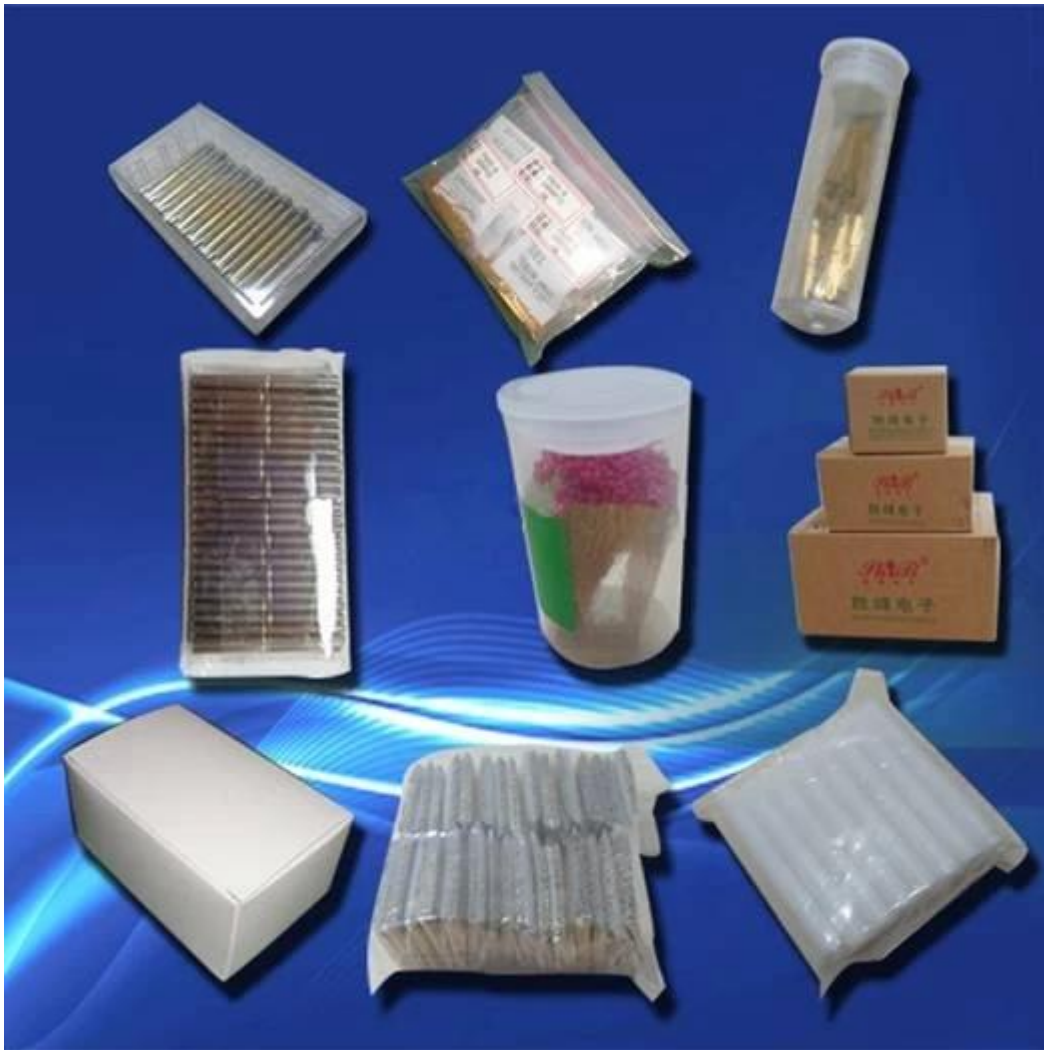

Shipping

