

Specifiche di prodotto

Codice articolo	SF-PPA1.7*7.95
Materiale	Canna: ottone, placcato Au n Ni Pistone: Ottone, Au on Ni placcato Primavera: SWP
Valutazione attuale	3A
Corsa completa	2,0 mm

Disegno del prodotto

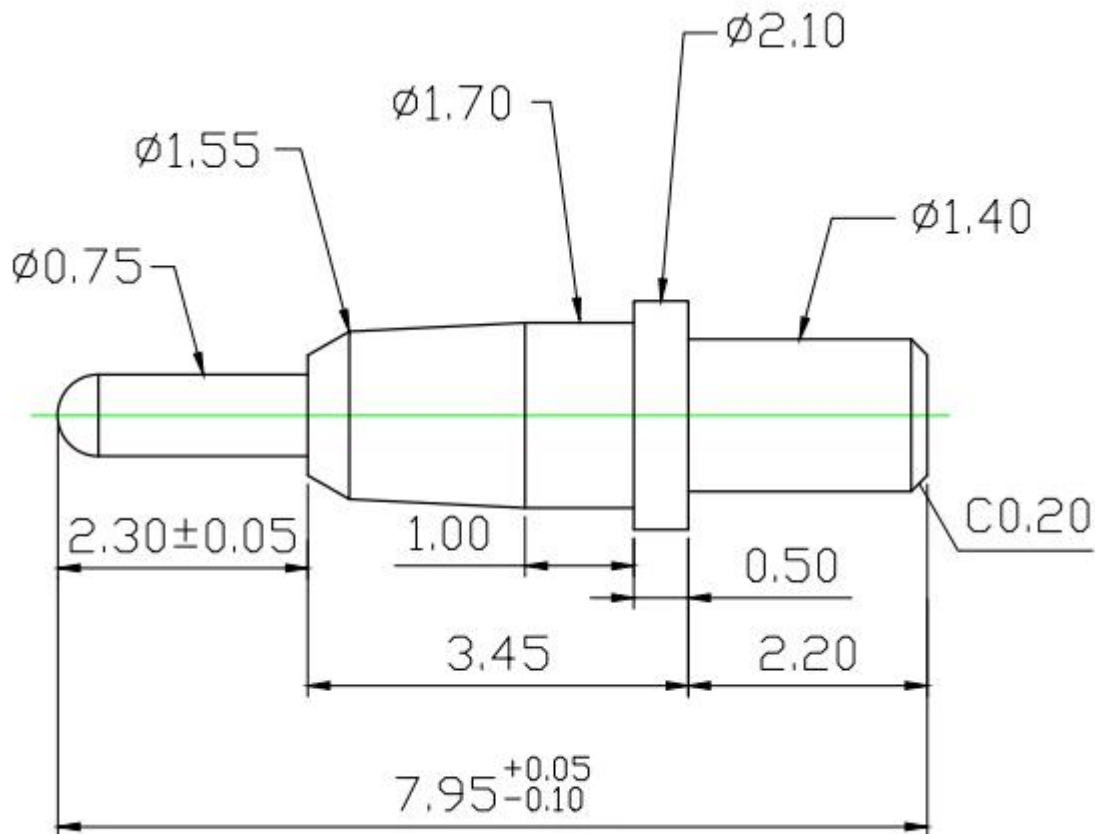

Nostro servizio

1. Possiamo rispondere alla tua richiesta entro 24 ore lavorative.
2. Il design personalizzato è disponibile e gli OEM sono i benvenuti.
3. Possiamo consegnare i perni della sonda ai nostri clienti in tutto il mondo con velocità e precisione.
4. Possiamo fornire al nostro cliente il prezzo più basso con un prodotto di alta qualità.

Prodotti Principali

Perno caricato a molla (singolo) per test PCB, ICT, FCT ecc;

Pin Pogo (connettore) per stabilire una connessione tra due circuiti stampati per applicazioni di ricarica, localizzazione, batterie, semiconduttori e interconnessione;

Sonda a doppia estremità per test BGA e semiconduttori;







Perno universale senza molla, perno rivestito, perno LM con serie QZ e VZ;

Sonda per alta corrente, sonda interruttore, ago capacitivo;

Terminale e presa/presa;

Altri componenti elettronici correlati, cavo 30# OK, serrature Jig, POM, cerniera in ferro ecc

Controllo di qualità

Spring exhausted tester	DC power supply	Current resistance tester
		
Microscope	Tensile strength tester	Spring tester
		

Certificazione



Quality Management System Certificate of Approval

This is to certify that the QMS of

Suzhou Shengyifurui Electronic Technology Co.,Ltd

Unified Social Credit Code:91320506MA1NRNLF6N

Registration Address:Room 5277 Tianlong Building, No.378 Zhujiang Nan Road, Mudu Town,
Wuzhong District, Suzhou City

Business Address:Room 103 Units 2 Building 4, Xiangtihuayuan, No.567 Binhe Road, SND, Suzhou City

Has been assessed and found to meet the requirements of

GB/T 19001-2016/ISO 9001:2015

This certificate is valid for the following scope of operations:

Sales of test probes and related accessories

Date of Certificate Issue: Dec, 06, 2018

Certificate Valid Until: Dec, 05, 2021

Certificate Number: **QM291812020**

The validity of the registration will be continued only when the organisation pass the annual surveillance audit.
Check the validity of certificate at www.cnca.gov.cn or www.das-china.com

Surveillance Audits:

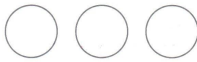

Authorized by:

Chief Executive



Shanghai DAS Certification Co., Ltd., member of SN Registrars(Holdings) Ltd.

Add:505, Tower. 2, Guoson Center, No. 388, Zhongjiang Road, Shanghai, P.R.China, 200062
Tel: 0086-21-62773910 Fax:0086-21-62080319
Web:<http://www.das-china.com>
Email: info@das-china.com
UK Head Office: DAS Certification Limited (On Behalf of SN Registrars (Holdings) Limited)
ADD: Registration House, 22b Church Street, Rushden,
Northamptonshire, NN10 9YT, UK
Tel: +44(0)1933 381859
Email: info@dascertification.co.uk
Web: www.dascertification.co.uk
Company Number: 07659067



Immagine dell'imballaggio

