

## **Product Name:SF-pogo pin**

### **Material and finishes**

**Plunger:Be Cu,Rh plated**

**Barrel:Brass,Gold plated**

**Spring:Stainless steel**

### **Detail Pictures**

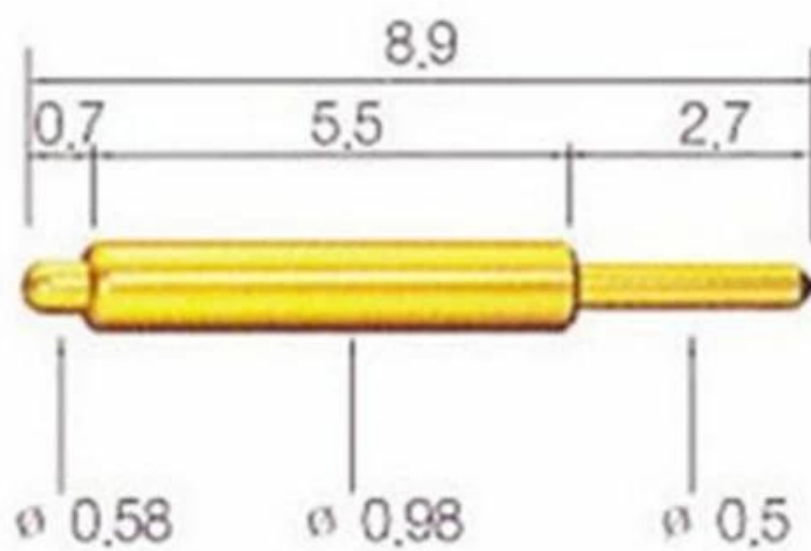

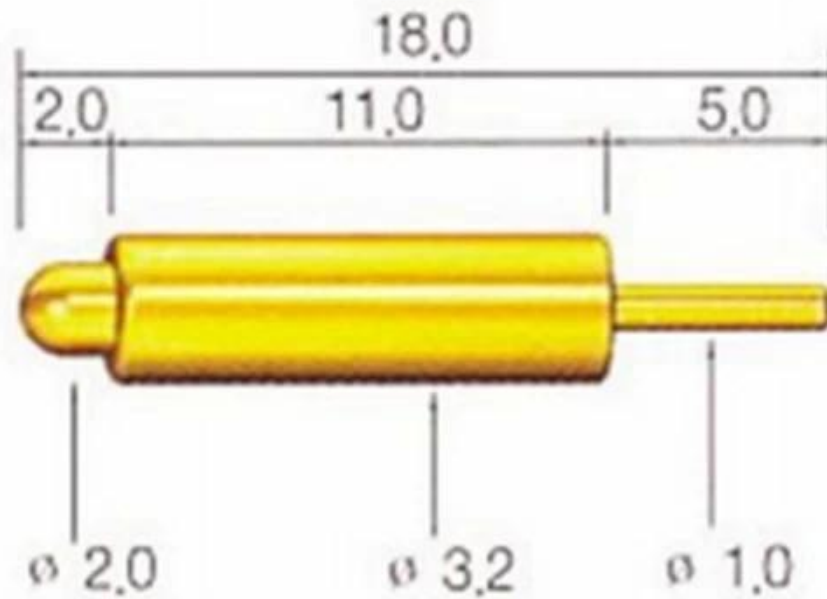

- Any tips,we could provide for you
- If you are interested in it,pls contact me

**ShengFeng Probe**

Our company established in 1984, Shengfeng Probe, the register name of Suzhou Shengteng Electronic Co., Ltd, specializing in the spring probe & the pogo pin & Terminal block with good quality, fast delivery and best service.





## Our Advantages

1. we have 30 years experience in probe pin and have ourself factory.
2. we provide free sample and have a testing department.
3. we could manufacture products as your request.
4. we guarantee best price and good service.

## Our factory



# Our equipment

Spring exhausted tester	DC power supply	Current resistance tester
 A tall, white, cabinet-style machine with a glass door and a control panel on the right side.	 A white, rectangular device with a black front panel. It features a red power switch, several knobs, and output terminals. The text "YoRi ADJUSTABLE DC POWER SUPPLY" is visible on the panel.	 A white, rectangular device with a large green digital display showing "8888". It has a warning symbol and a "STOP" button on the right side.
Microscope	Tensile strength tester	Spring tester
 A white and black compound microscope on a wooden desk.	 A mechanical testing machine with a blue base and a vertical frame, used for tensile testing.	 A mechanical testing machine with a white base and a vertical frame, used for testing springs.

# package

