

□□□□

□□□□	SFENG
□□□□	SF-PV1-H-H□M8*26.5
□□□□□□	□□□□□□□□
□□	□□□□□□□□
□□	150A
MOQ	100□
□□□□□□	□□□□□□□□□□□□7□□□□

□□□□□

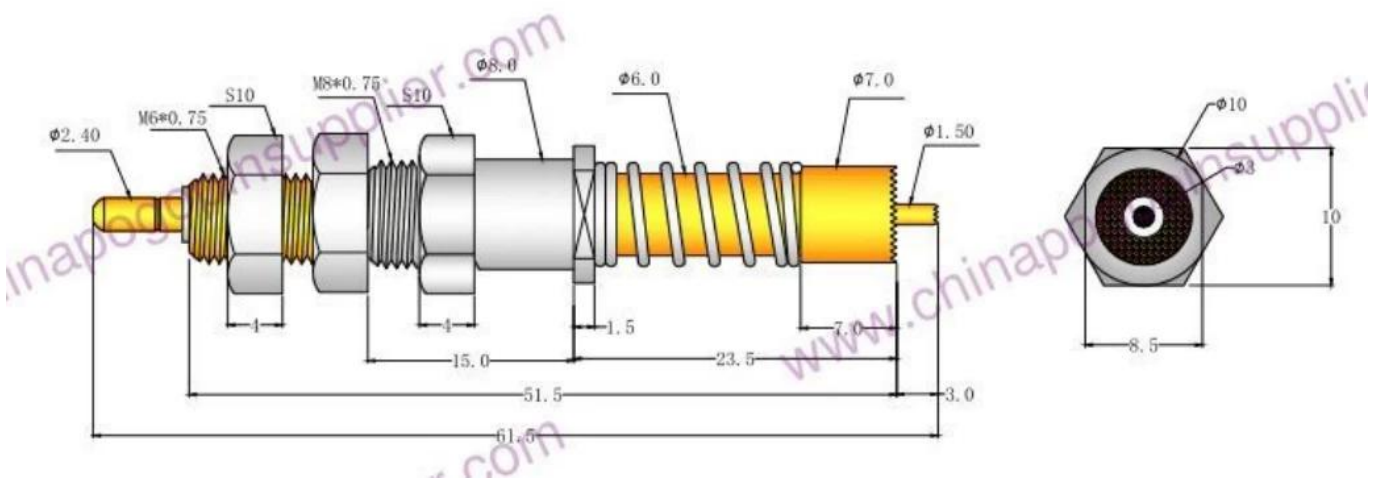

□□□□



chinapogopinsupplier.com

公司简介

1. 24小时在线客服
2. 提供OEM定制服务
3. 品质保证
4. 价格公道

产品

PCB ICT FCT 测试设备 (探针)

探针 (探针) 探针 2 探针

BGA 探针







探针 QZ VZ LM

□□□□□□□□□□□□□□□□□□□□;

□□□□□□□□□□□□□□□□□□□□;

□□□□□□□□□□30# OK □□□□□□□□□□POM□□□□□□□□

□□□□

Spring exhausted tester	DC power supply	Current resistance tester
		
Microscope	Tensile strength tester	Spring tester
		

□□□□□□

