

產品名稱

產品名稱	SFENG
產品型號	SF-32*83
產品規格	
材料	SUS304
重量	4500g
長度	6mm
電流	20A
電阻	10mΩ
MOQ	100
包裝規格	每包7個

產品圖

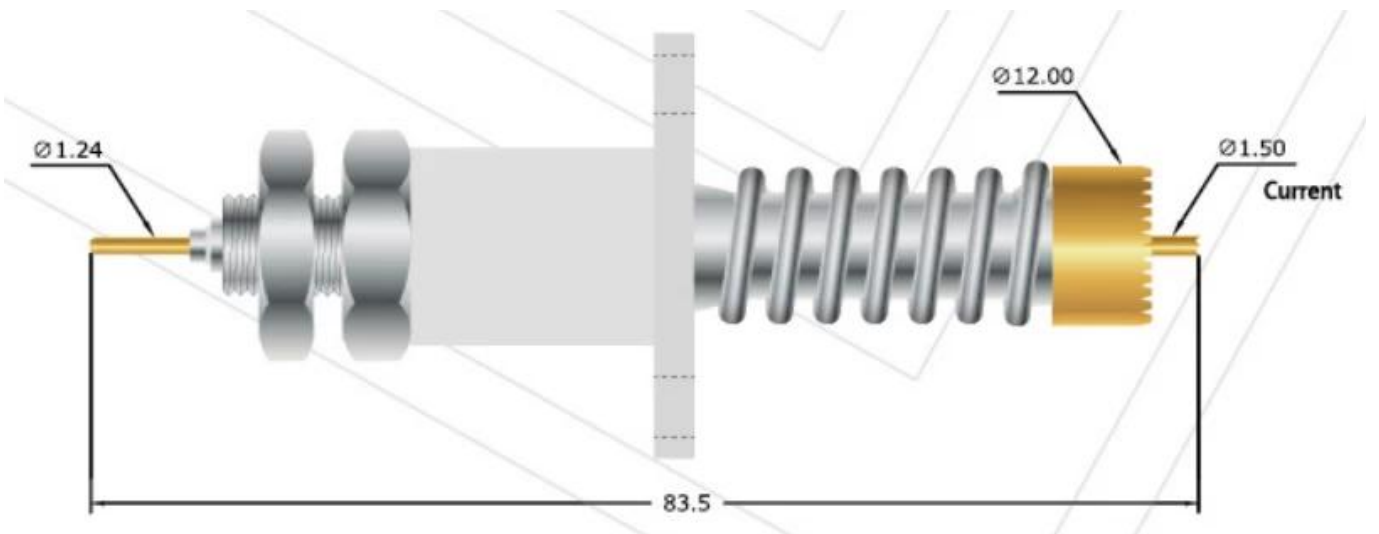

產品規格

1. 產品規格24個
2. 產品規格OEM
3. 產品規格
4. 產品規格 .

產品圖

PCB ICT FCT 產品規格 (產品)

產品規格 2 產品規格 (產品)

BGA 產品規格







產品規格 QZ VZ LM

產品規格;

產品規格/;

30#OKPOM

□□□□

Spring exhausted tester	DC power supply	Current resistance tester
		
Microscope	Tensile strength tester	Spring tester
		

□□□□

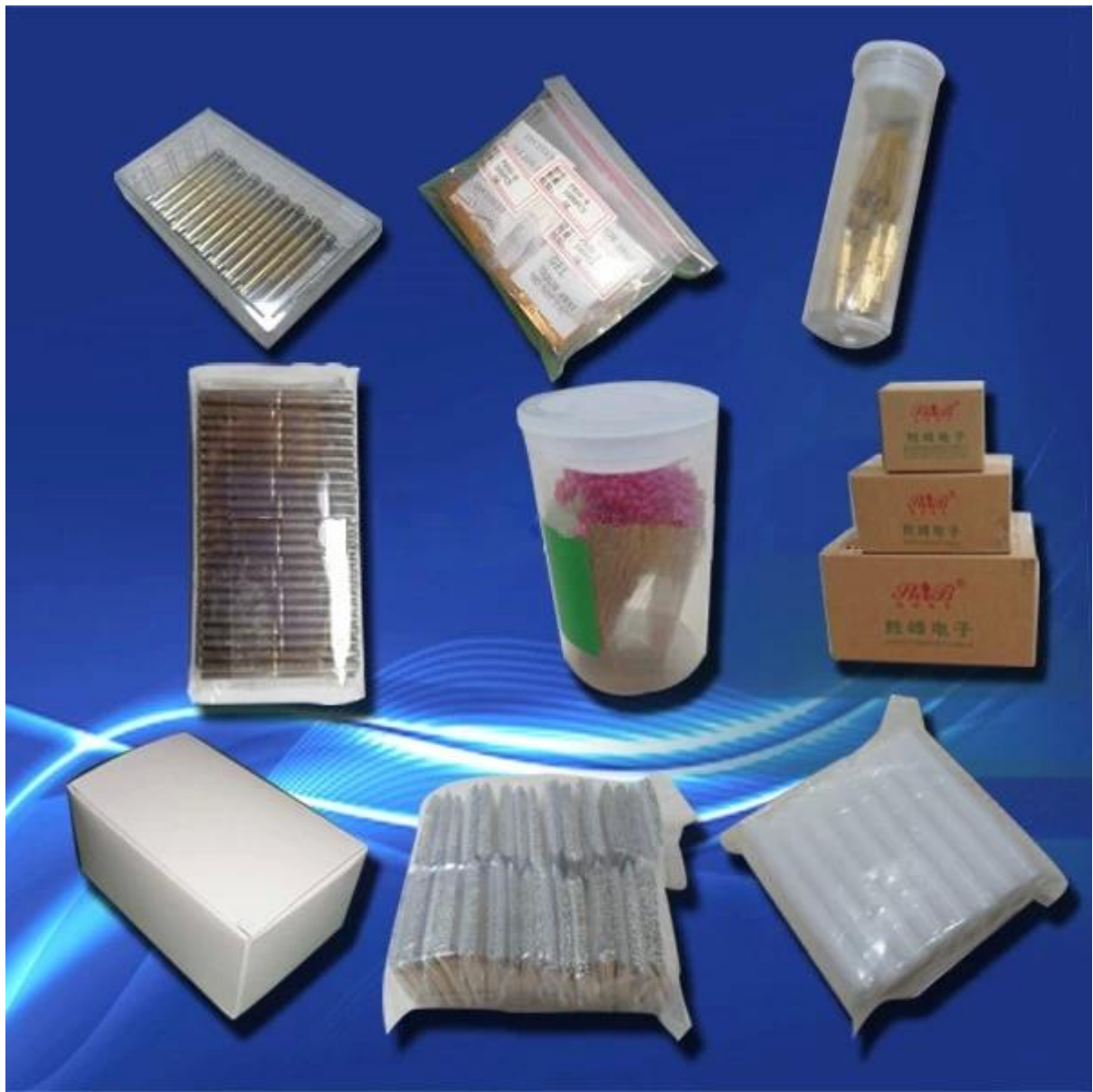

□□□□□□

