

□□□□

□	SFENG
□□□□ □□	SF-PV1-H-H M11×26.5
□□□□□□	□□□□□ □
□□	□□
□□□□	□□□□□□
□□□□ □	280g±20% @3.0mm □□ □□□□□□□□
□□ □	50A
□□□□□	□□□□□□□□□□
□□□	□□□
□□□□□□	□□□
MOQ	100□
□□□□□□	□□□□□□□□□□□7□□□

□□ □□□□







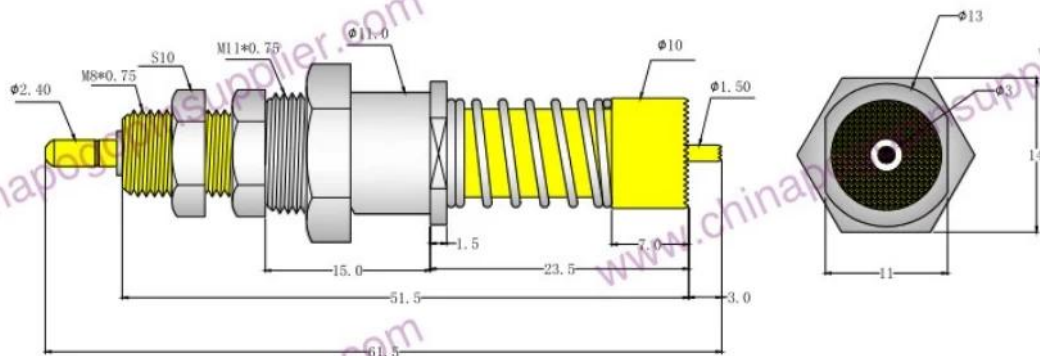

技术参数

- 1、中心针 铍铜/镀金
- 2、大针杆 黄铜/镀金
- 3、针套 黄铜/镀镍
- 4、螺帽 黄铜/镀镍
- 5、弹簧 SUS304
- 6、弹力 中心针 下压3.0 280-300g  
大针杆 压平 2000g

说明: 1、所有尺寸的单位为mm  
2、未注图示尺寸公差:  
X.  $\pm 0.1$   
X.X  $\pm 0.05$   
X.XX  $\pm 0.02$







公司简介

1. 24小时在线客服
2. 提供OEM服务
3. 提供技术支持
4. 提供物流配送

产品

PCB ICT FCT 测试设备 (进口)  
 进口 (进口) 测试设备 2 测试设备  
 BGA 测试设备  
 测试设备 QZ VZ LM  
 测试设备;  
 测试设备/进口;  
 测试设备 30# OK 测试设备 POM

服务

Spring exhausted tester	DC power supply	Current resistance tester
		
Microscope	Tensile strength tester	Spring tester
		

□□□□

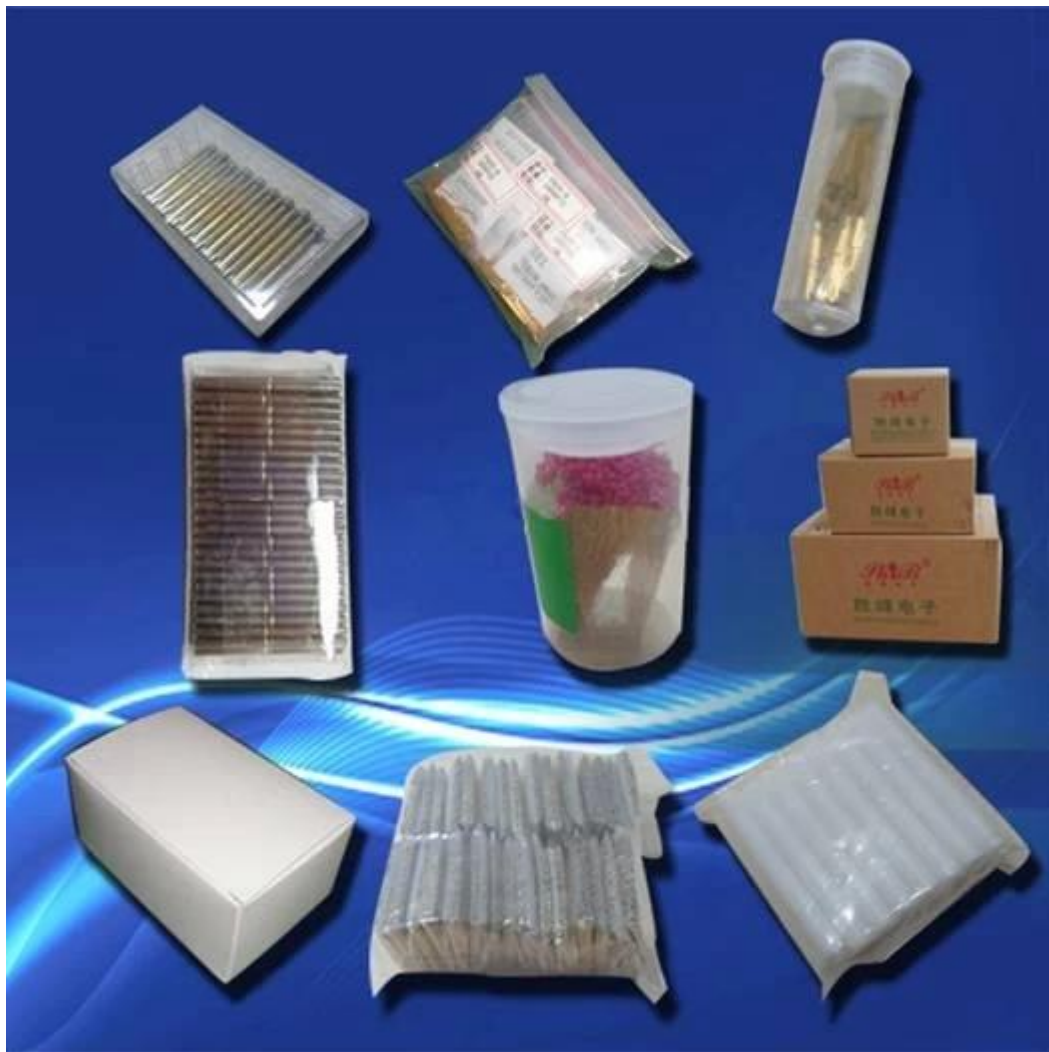

□□□

