

□□□□

□□□□	SFENG
□□□□	□□□□□□□□ ϕ 0.3* 6.7
□□□□□□	SK4□□□□□□□□
□□□	□□□
□	SK4□□□□□
□□□□□□	20□□□□
□□□□□	1A
□□□□□	50mohm□□
□□□□□□	2.75□□□□□□
MOQ	100 □
□□□□□□	7 □□□□□□□□□□□□

□□□□□

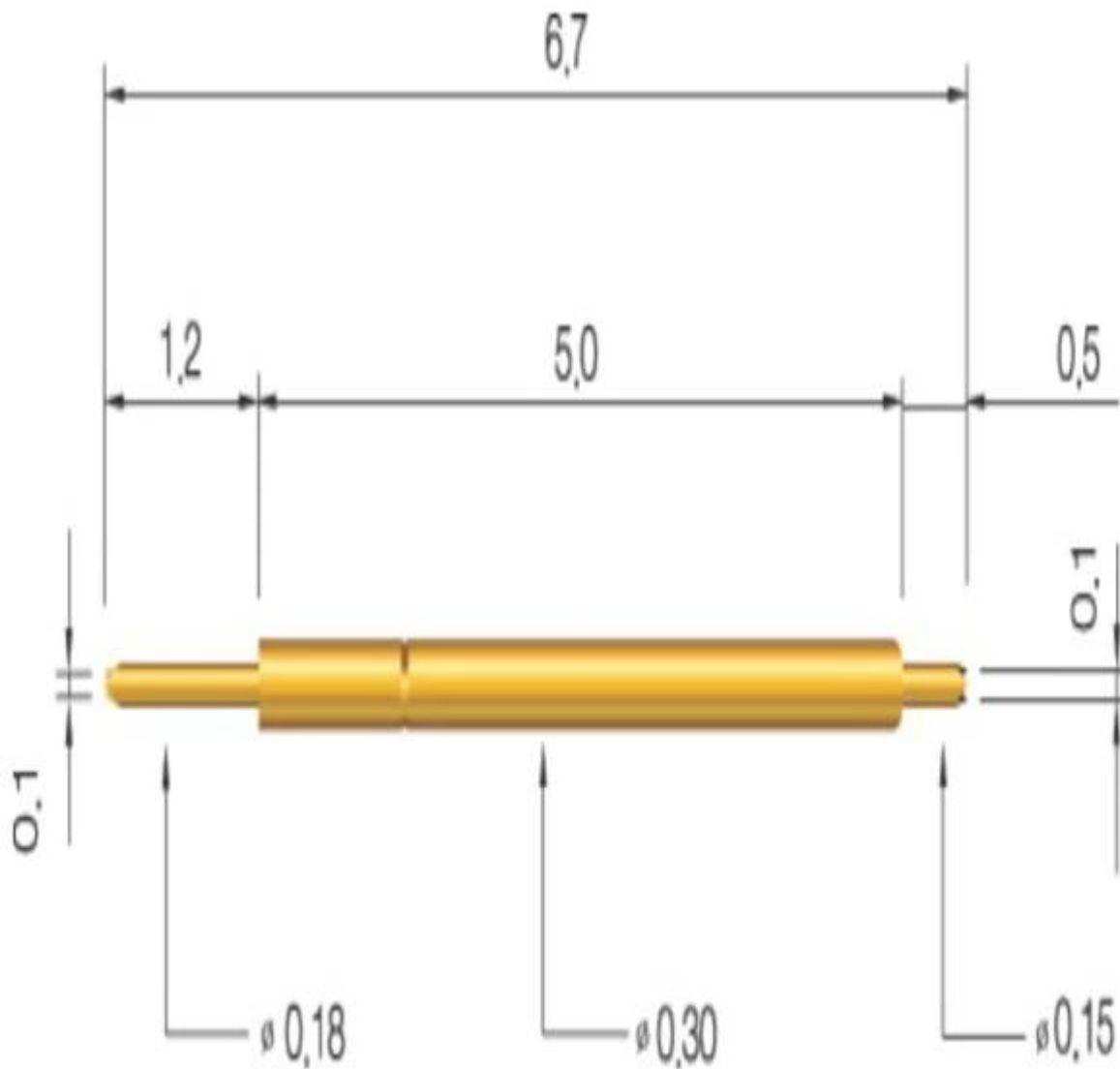

□□□□□□

- 1.Reply 24□□□□withn□□□□□□
- 2.Customized □□□□□□OEM□□□□□□□□
- 3.Delivery □□□□□□□□□□□□□□□□□□□□
- 4.provide □□□□□□□□□□□□□□□□

□□□□

---□□□□□□□□ PCB□ICT□FCT□□□□□□□□□□□□

---□□□□usuallytemporary□□□□□□□□□□□□□□□□

□□□□□□□□□□□□&□□□□□□□□□□□□□□□□□□□□

interconnectApplications;

---□□□□□□□□ probef orBGA&□038; semiconudtion□□□□







---□□□□□□□□□□□□□□coatingpin□LM□□withQZ&□038; VZseries□

---□□□□□□□□□□□□□□□□□□□□...

---□□□□□&□038;□□□□□□/□□□□□□

---□□□□□□□□□□□□□□□□□□□□□□□□POM□Ironhinge□□

□□□□

Spring exhausted tester	DC power supply	Current resistance tester
		
Microscope	Tensile strength tester	Spring tester
		

□□□□□□

