

RF 零件

零件	SFENG
零件 零件	零件 零件 SF-32*83.5
零件	零件
零件	零件
零件	SUS304
零件	4500g
零件 零件	6mm
零件 零件	20A
零件 零件	<10mΩ
MOQ	100PCS
零件	零件 零件 零件 零件 7

RF 零件

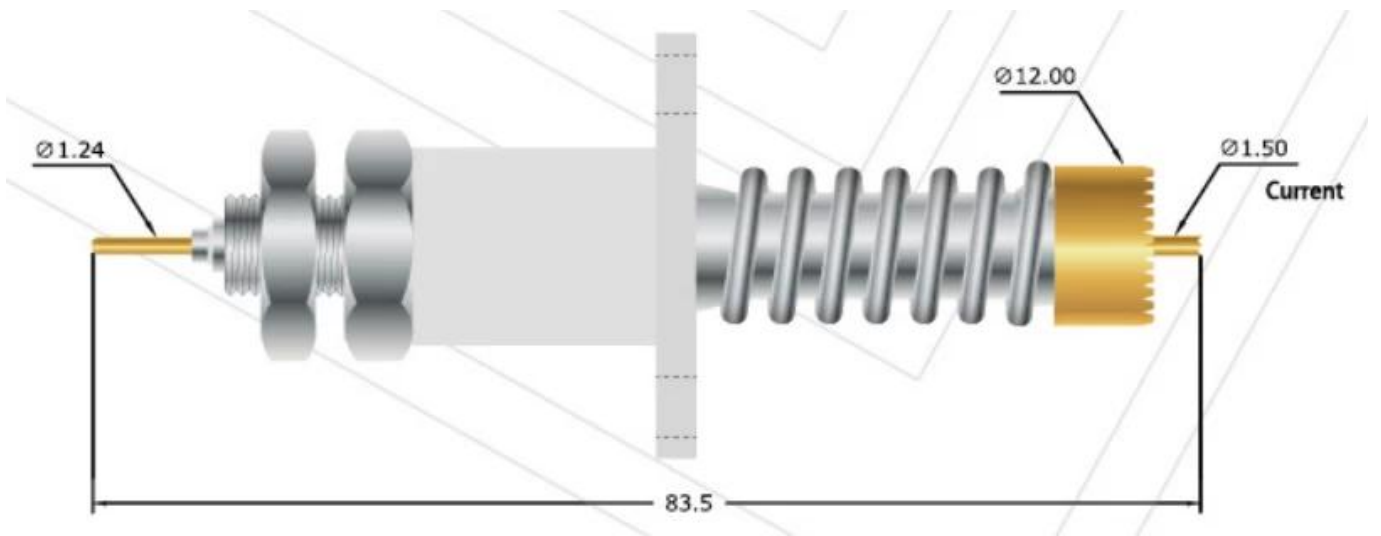

RF 零件

1. 零件 24 零件 零件 零件 零件 零件 零件 零件 零件 零件.
2. 零件 零件 零件 OEM 零件.
3. 零件 零件 零件 零件 零件 零件 零件 零件 零件 零件.
4. 零件 零件 零件 零件 零件 零件 零件 零件 零件 零件. .

RF 零件

PCB, ICT, FCT 零件 零件 零件 零件 零件 (零件);

零件, 零件 零件, 零件, 零件 零件 零件 零件 零件 零件 零件 零件 零件 零件 零件 零件 零件 (零件)

BGA 零件 零件 零件 零件 零件;







零件 零件 零件, 零件, QZ 零件 VZ 零件 零件 LM 零件;

零件 零件, 零件 零件, 零件 零件;

零件 零件 /零件;

□□ □□ □□, 30# OK □□□, □□ □□ □□, POM, □ □□ □

□□ □□

Spring exhausted tester	DC power supply	Current resistance tester
 A tall, white, cabinet-style machine with a glass door on the upper half and a control panel on the right side.	 A white, rectangular device with a black front panel. It features a red power switch, several analog meters, and output terminals. The brand name 'YoRI' is visible.	 A white, rectangular device with a large green digital display showing '8888'. It has a control knob and a warning symbol on the right side.
Microscope	Tensile strength tester	Spring tester
 A white and black compound microscope with a stage, objective lenses, and an eyepiece.	 A blue and white mechanical testing machine with a vertical column and a sample holder.	 A white mechanical testing machine with a digital display and a control panel, used for testing springs.

□□ □□

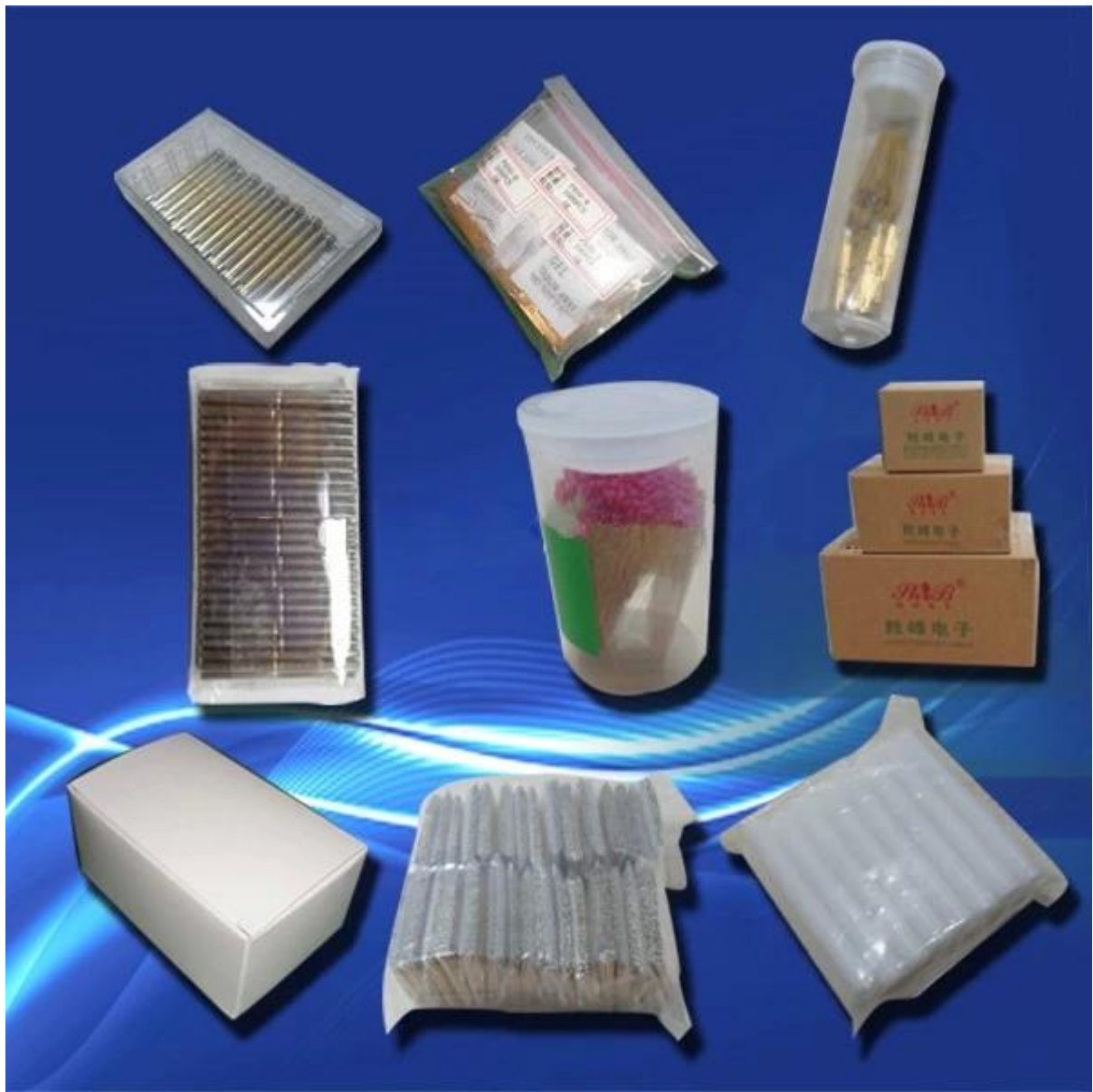

□□ □□

