

□□ □□

□□□ □□	SF-PPA1.7*7.95
□□	□□:□□, Au Ni □□ □□□:□□, Au Ni □□ □: SWP
□□ □□	3A
□ □□□□	2.0mm

□□ □□

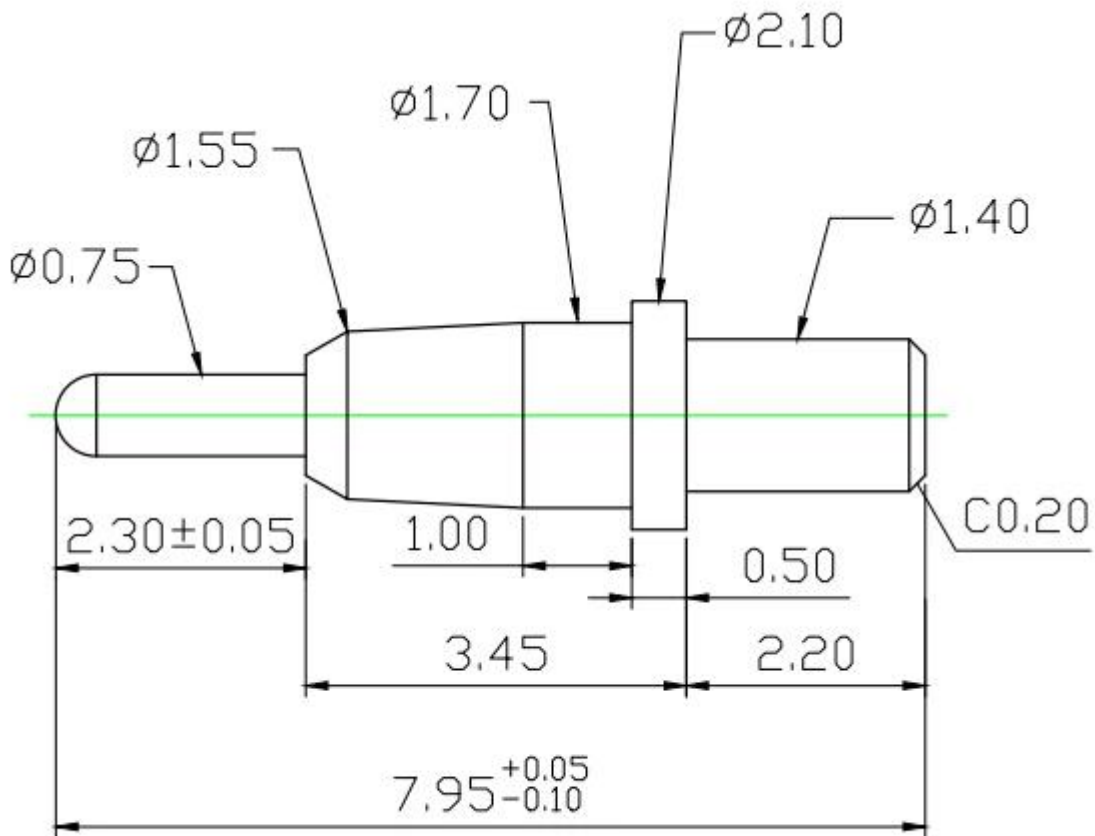

□□□ □□□

1. □□□ □□ □□ 24□□ □□□ □□□ □□□ □ □□□□.
2. □□□ □□□□ □□□□ OEM□ □□□□□.
3. □□□ □ □□ □□□□ □□□ □□□□ □□□ □ □□□□.
4. □□□ □□□□ □□□ □□□ □□ □□□□ □□□ □ □□□□.

□□ □□

PCB, ICT, FCT □□□ □□ □□ □□□ □□ □(□□);

□□, □□ □□, □□□□, □□□□ □ □□□□□ □□□□□□ □□ □ □□ □□ □□ □□□ □□□ □□ □□□□

BGA □ □□□ □□□□ □□ □□ □□□□;







□□□□ □□ □□ □□, □□ □□, QZ □ VZ □□□□ □□ LM □;

□□□ □□□, □□□ □□□, □□□□□ □□;

□□□ □ □□□ /□□;

□□ □□ □□ □□, 30# OK □□□□, □□ □□ □□, POM, □ □□ □

□□ □□

Spring exhausted tester	DC power supply	Current resistance tester
		
Microscope	Tensile strength tester	Spring tester
		

□□



## Quality Management System Certificate of Approval

This is to certify that the QMS of

### Suzhou Shengyifurui Electronic Technology Co.,Ltd

Unified Social Credit Code:91320506MA1NRNLF6N

Registration Address:Room 5277 Tianlong Building, No.378 Zhujiang Nan Road, Mudu Town,  
Wuzhong District, Suzhou City

Business Address:Room 103 Units 2 Building 4, Xiangtihuayuan, No.567 Binhe Road, SND, Suzhou City

Has been assessed and found to meet the requirements of

**GB/T 19001-2016/ISO 9001:2015**

This certificate is valid for the following scope of operations:

Sales of test probes and related accessories

Date of Certificate Issue: Dec, 06, 2018

Certificate Valid Until: Dec, 05, 2021

Certificate Number: **QM291812020**

The validity of the registration will be continued only when the organisation pass the annual surveillance audit.  
Check the validity of certificate at [www.cnca.gov.cn](http://www.cnca.gov.cn) or [www.das-china.com](http://www.das-china.com)

Surveillance Audits:



Authorized by:

Chief Executive



Shanghai DAS Certification Co., Ltd., member of SN Registrars(Holdings) Ltd.

Add:505, Tower. 2, Guoson Center, No. 388, Zhongjiang Road, Shanghai, P.R.China, 200062  
Tel: 0086-21-62773910 Fax:0086-21-62080319  
Web:<http://www.das-china.com>  
Email: [info@das-china.com](mailto:info@das-china.com)  
UK Head Office:DAS Certification Limited (On Behalf of SN Registrars (Holdings) Limited)  
ADD: Registration House, 22b Church Street, Rushden, Northamptonshire, NN10 9YT, UK  
Tel: +44(0)1933 381859  
Email: [info@dascertification.co.uk](mailto:info@dascertification.co.uk)  
Web: [www.dascertification.co.uk](http://www.dascertification.co.uk)  
Company Number: 07659067



