

□□ □□

□□	SFENG
□ □□	SF-HCP10 * 70
□□□	□□
□	□□
□	SUS
□ □	customzied
□□□ □□	customzied
□□ □□	(30A)
MOQ	100 □
□□ □□	7 □□ □□□□ □ □

□□ □□

SFENG
The China's The World's

RoHS ISO 9001 CE

chinapogopinsupplier.com

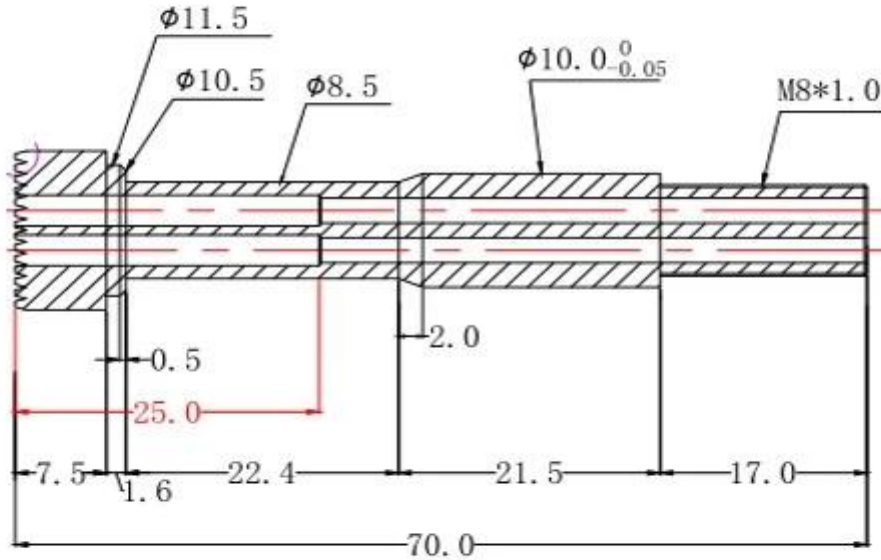

chinapogopinsupplier.com

□□□ □□□

1. □□□ □□ □ □ □□□□ 24 □□ □□ □□□ □□.
2. □□□ □□ □□□□ □□□□, OEM □ □□□□□.
3. □□□ □□ □ □ □□□□ □□ □□□ □□□ □□□ □□□ □.
4. □□□ □□ □ □ □□□□ □□□ □□□ □□ □□□ □□ □□.

□□ □□

PCB, ICT, FCT □□□ □□□□ □□□□□ □ (□□);

□□ □ (□□□) □□□ □□ □□ □□ □□□ □□□□□, □□ □□, □□□, □□□ & A; □□ □□ □□ □□□□;

BGA □□□ □□□□□□ □□ □□ □□□;







□□ □□ □, □□ □, QZ □ VZ □□□ LM □;

□□ □□ □□□, □□□ □□□□, □□ □□ □□;

□□□ & A; □□ / □□;

□□ □□ □□ □□, 30 # OK □□□, □□ □□ □□, POM, □ □□ □

□□ □□

Spring exhausted tester	DC power supply	Current resistance tester
		
Microscope	Tensile strength tester	Spring tester
		

□□ □□

