

□□ □□

SF021B570U11

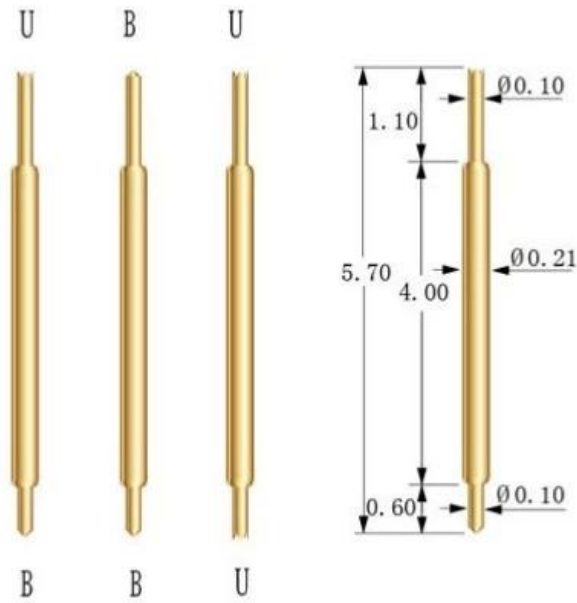

□□□ □□□

1. □□□ 24 □□ □□□ □□□ □□□ □□ □ □ □□□□.
2. □□□ □□□ □□□□ □□□□ □□ □ OEM□ □□□□.
3. □□□ □□□ □□□□ □ □□ □□□□ □□□ □□ □□□□ □ □□□□.
4. □□□ □□□□ □□□□ □□□ □□ □□□□ □□ □ □ □□□□.

□□ □□

□□□□□□ (□□) PCB, ICT, FCT □□□□ □;

□□□□□□ (□□□□) 2 □□ □□ □□ □□ □□□ □□□□ □□, □□ □□, □□□□, □□□□ & □□ □□ □□ □□□□;

□□□□□□ BGA □ □□□□□□□;







□□□□ □□□ □□□, □□ □□, LM □ QZ □ VZ □□□□;

□□□□□□□□, □□□□□□□□, □□□□□□ □□;

□□□□ & □□□□ / □□□□;

□□ □□ □□, 30 # OK □□, □□ □□ □□, POM, □ □□ □

□□ □□

Spring exhausted tester	DC power supply	Current resistance tester
		
Microscope	Tensile strength tester	Spring tester
		

□□ □□

