

00 00

00	SFENG
00 00	00 00 0 $\varnothing 0.3 * 6.7$
000	SK4 000
0	00
0	SK4 00 000
0 00	20g
00 00	1A
00 00	50mohm 00
00 00 00	2.75mm
MOQ	(100) 0
00 00	7 00000 0 000

00 00

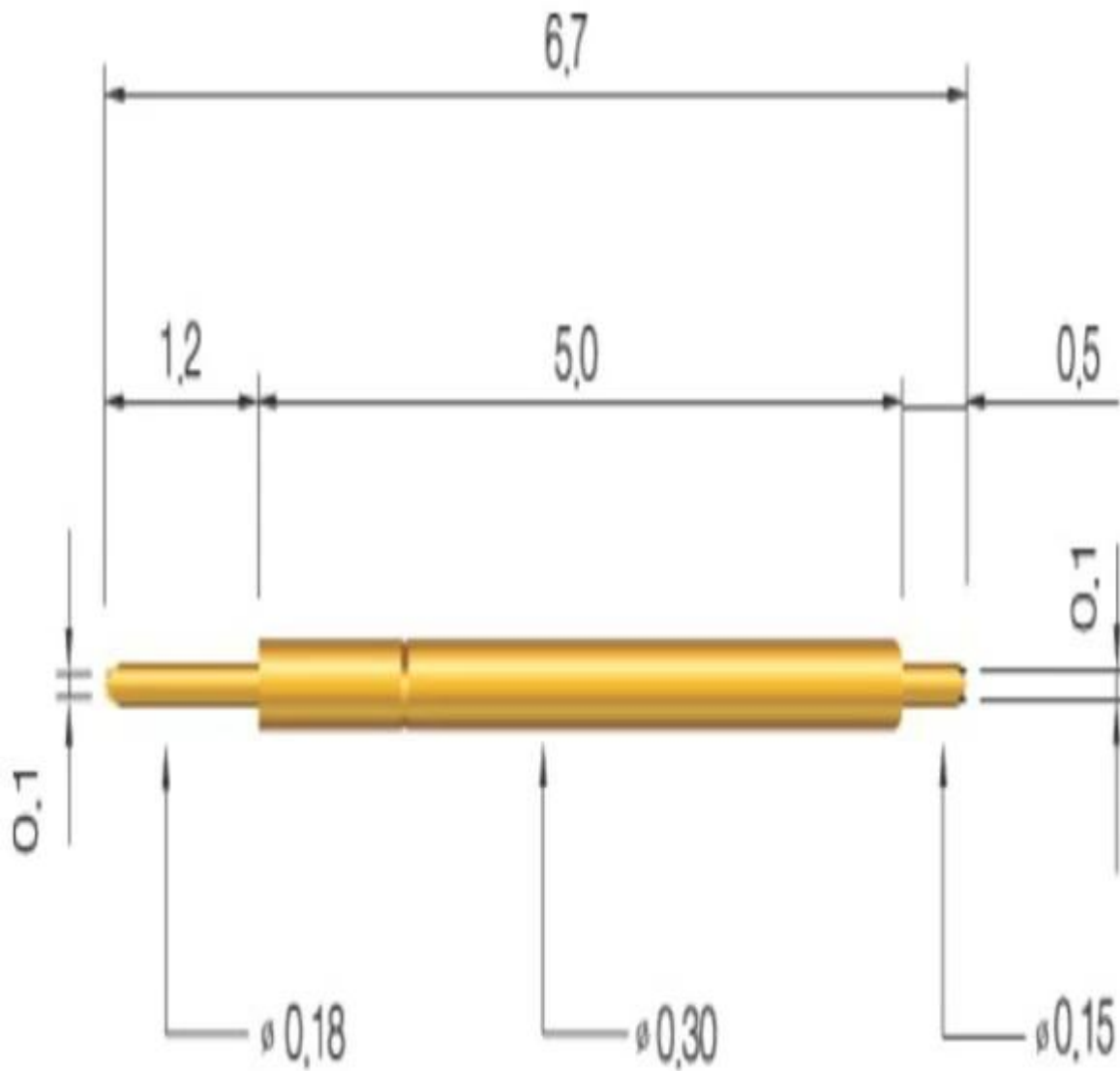







□□□ □□□

1. Reply 24 □□ □□ withn □□
2. Customized □□□□ □□□□, OEM □□
3. Delivery □□□ □□□□ □ □□ □□□□ □□□ □
4. provide □□□ □□□□ □□ □□ □□ □□

□□ □□

- □□□ □ □ PCB, ICT, FCT □□□□□□ (□□)
- □□ □ (□□□□) □□□ (usually temporary) □□□ □□□□□□
□ , □□ □□□, □□□ & A □□□□□ □□ □□ □□;
interconnectApplications;
- □□ □□ probef orBGA & A, semiconudtion □□□;
- □□ □ □□□, coatingpin, LM □ withQZ & A; VZseries;
- □□ □□ □□□, □□□ □□□, □□ □□ ...
- □□□ & A, □□ / □□;
- □□ □□ □□ compents, 30 # OKwire, □□ □□ □□, POM, Ironhinge □

□□ □□

Spring exhausted tester	DC power supply	Current resistance tester
		
Microscope	Tensile strength tester	Spring tester
		

□ □ □ □

