

Productspecificatie

Merk	SFENG
Item nummer	SF-PA3.0*43-G
Plunjer	Ph, Au on Ni verguld
Loop	Messing, Ni verguld
Lente	SUS304
Lente kracht	1500g
Huidig rantsoen	6A
Stroomweerstand	50 mΩ
MOQ	100 stuks
Doorlooptijd	7 werkdagen na ontvangst van de betaling

Producttekening

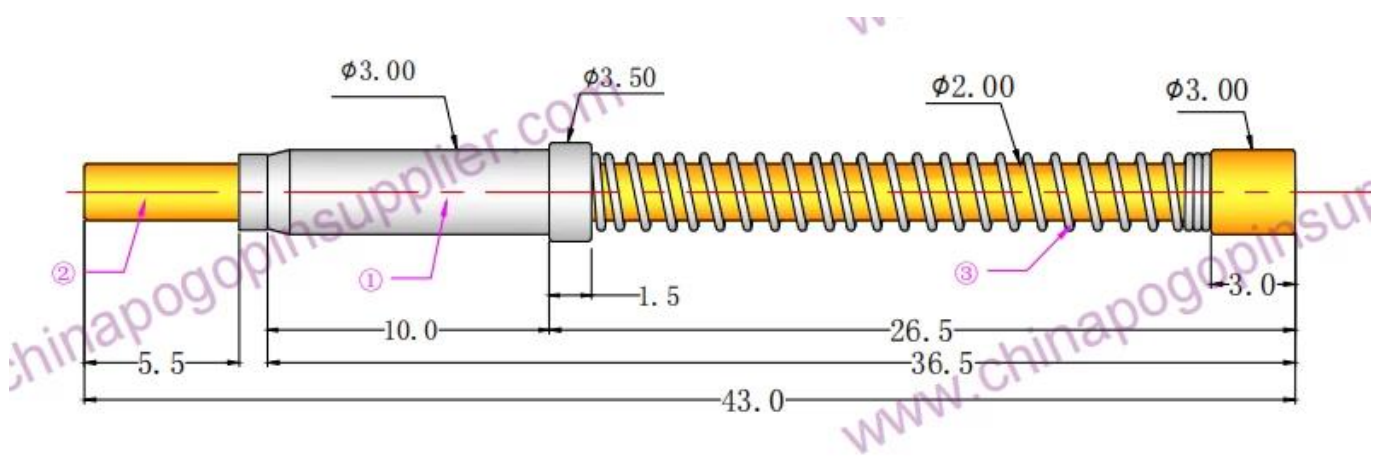

Productfoto

SFENG
The China's The World's



chinapogopinsupplier.com

Onze service

1. Wij kunnen uw vraag binnen 24 werkuren beantwoorden.
2. Het aangepaste ontwerp is beschikbaar en OEM is welkom.
3. We kunnen de sondepinnen snel en nauwkeurig aan onze klanten over de hele wereld leveren.
4. Wij kunnen onze klant de laagste prijs bieden met een product van hoge kwaliteit .

hoofd producten

Veerbelaste pin (enkel) voor PCB-, ICT-, FCT-testen etc;

Pogo-pin (connector) om verbinding tot stand te brengen tussen twee printplaten voor opladen, lokaliseren, batterij-, halfgeleider- en interconnect-toepassingen;

Sonde met twee uiteinden voor BGA- en halfgeleider tests;







Universele pin zonder veer, coatingpin, LM-pin met QZ- en VZ-serie;

Hoge stroomsonde, schakelaarsonde, capaciteitsnaald;

Terminal & stopcontact/aansluiting;

Andere gerelateerde elektronische componenten, 30 # OK-draad, malsloten, POM, ijzeren scharnier enz

Kwaliteitscontrole

Spring exhausted tester	DC power supply	Current resistance tester
 A tall, white, industrial-grade cabinet with a glass door and a control panel on the right side.	 A white, rectangular DC power supply unit with a black front panel. It features a red power switch, several output terminals, and a digital display.	 A white, rectangular electronic device with a large green digital display showing '8888'. It has a 'HIGH BEAK' warning symbol and a control knob.
Microscope	Tensile strength tester	Spring tester
 A white and black compound microscope with a large objective lens and a camera attachment.	 A blue and white mechanical testing machine with a vertical column and a sample holder.	 A white mechanical testing machine with a digital display and a control panel, used for testing springs.

Verpakkingsbeeld

