

Productspecificatie

Merk	SFENG
Item nummer	Coaxiale sonde SF-32*83,5
Plunjer	Becu
Loop	Messing
Lente	SUS304
Lente kracht	4500g
Aanbevolen slag	6 mm
Huidig rantsoen	20A
Huidige weerstand	<10mΩ
MOQ	100 STUKS
Doorlooptijd	7 werkdagen na ontvangst van de betaling

Producttekeningen

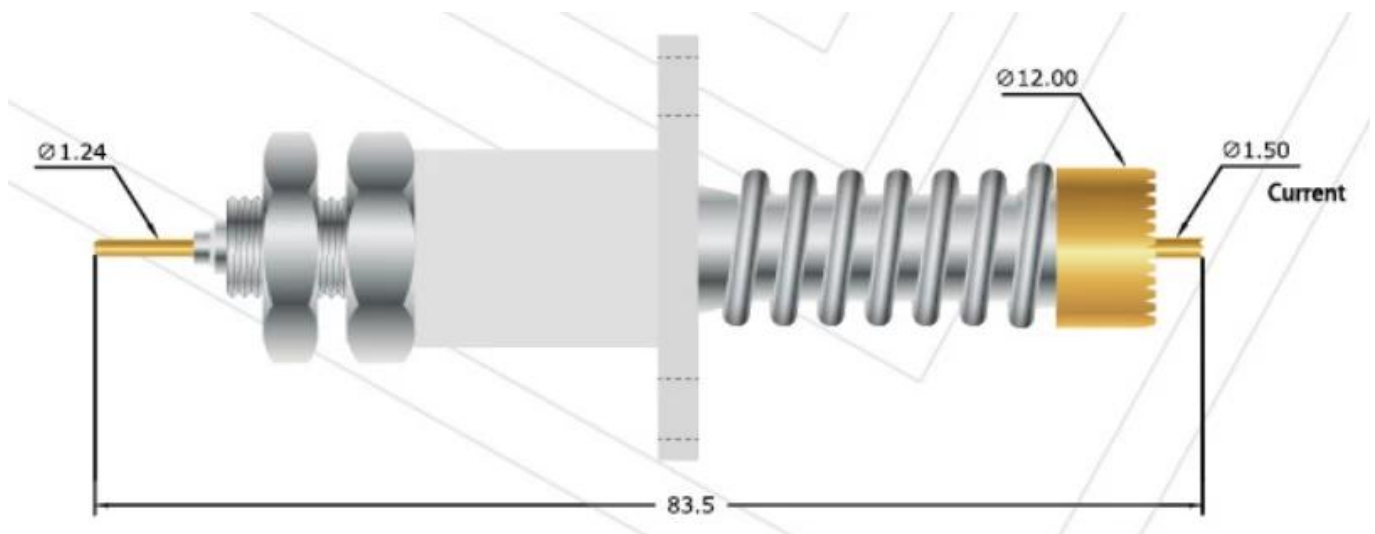

Onze service

1. Wij kunnen uw vraag binnen 24 werkuren beantwoorden.
2. Het aangepaste ontwerp is beschikbaar en OEM is welkom.
3. We kunnen de sondepinnen snel en nauwkeurig aan onze klanten over de hele wereld leveren.
4. Wij kunnen onze klant de laagste prijs bieden met een product van hoge kwaliteit .

hoofd producten

Veerbelaste pin (enkel) voor PCB-, ICT-, FCT-testen etc;

Pogo-pin (connector) om verbinding tot stand te brengen tussen twee printplaten voor opladen, lokaliseren, batterij-, halfgeleider- en interconnect-toepassingen;

Sonde met twee uiteinden voor BGA- en halfgeleider tests;







Universele pin zonder veer, coatingpin, LM-pin met QZ- en VZ-serie;

Hoge stroomsonde, schakelaarsonde, capaciteitsnaald;

Terminal & stopcontact/aansluiting;

Andere gerelateerde elektronische componenten, 30 # OK-draad, malsloten, POM, ijzeren scharnier enz

Kwaliteitscontrole

Spring exhausted tester	DC power supply	Current resistance tester
 A tall, white, industrial-grade cabinet with a glass door and a control panel on the right side.	 A white, rectangular power supply unit with a black front panel. It features a red power switch, several knobs, and output terminals. The brand name 'YoRi' is visible.	 A white, rectangular electronic device with a large green digital display showing '8888'. It has a warning symbol and a power button on the right side.
Microscope	Tensile strength tester	Spring tester
 A white and black compound microscope with a digital camera attachment on top, mounted on a wooden desk.	 A blue and white mechanical testing machine with a vertical column and a sample holder, used for tensile testing.	 A white mechanical testing machine with a digital display and a control panel, used for testing springs.

Verpakingsbeeld

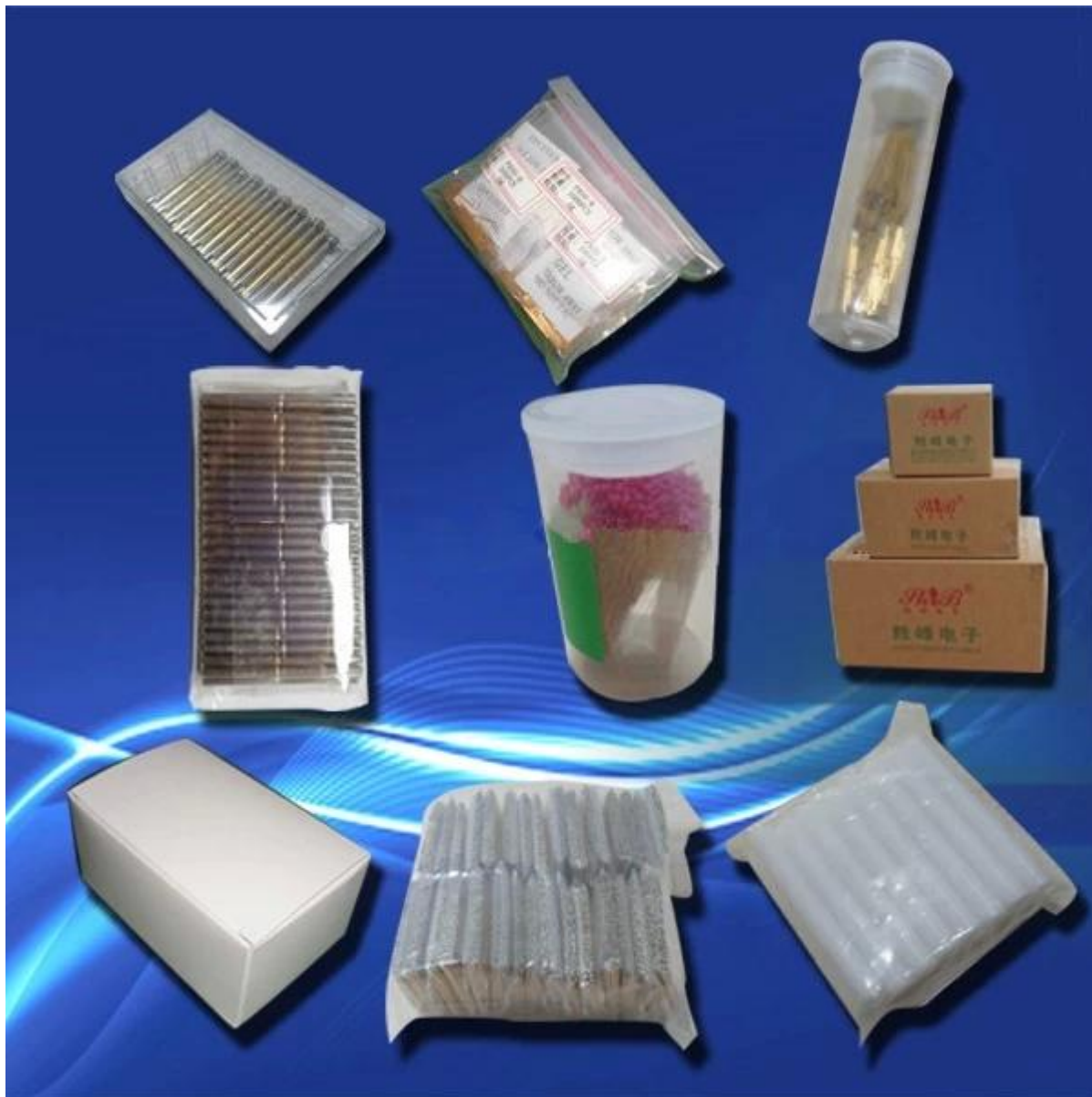

Fabrieksafbeelding

