

Productspecificatie

Artikelcode	SF-PPA1,7*7,95
Materiaal	Vat: messing, Au on ni verguld Plunjer: messing, Au on vernikkeld Lente: SWP
Huidige score	3A
Volledige slag	2,0 mm

Producttekening

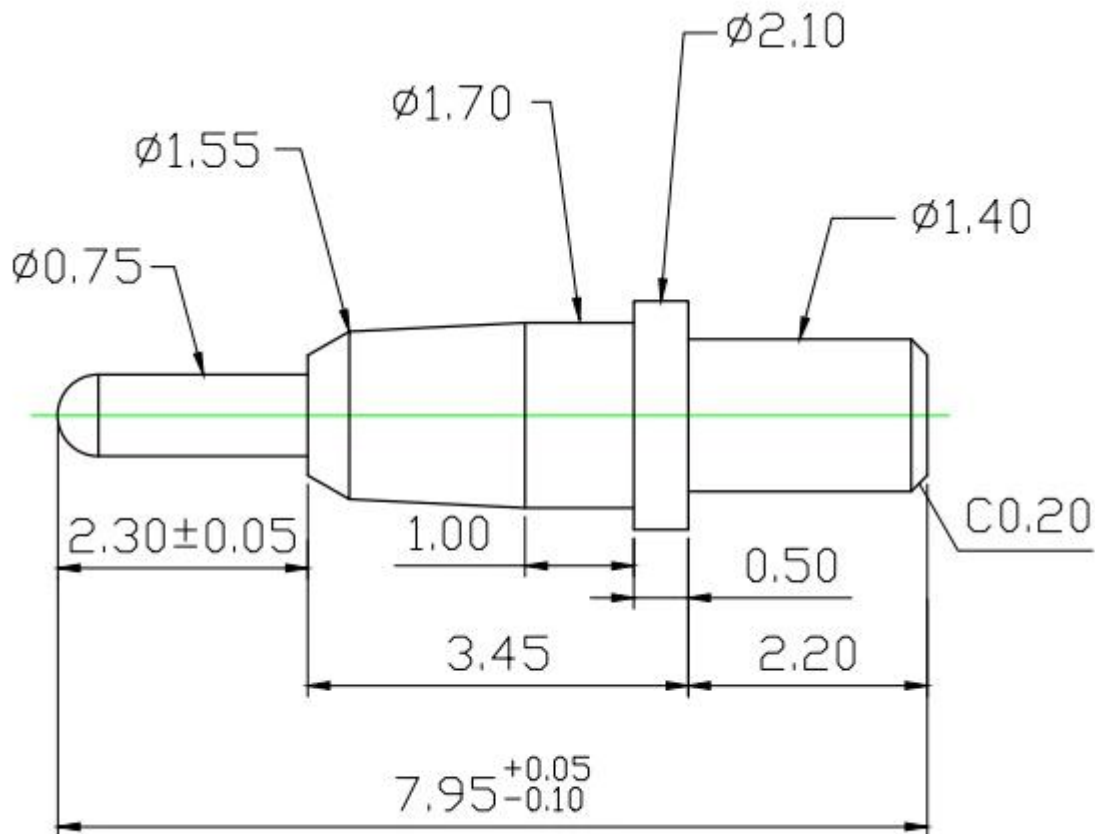

Onze service

1. Wij kunnen uw vraag binnen 24 werkuren beantwoorden.
2. Customiseddesign is beschikbaar en OEM is welkom.
3. We kunnen de sondepinnen snel en nauwkeurig aan onze klanten over de hele wereld leveren.
4. Wij kunnen onze klant de laagste prijs bieden met een product van hoge kwaliteit.

hoofd producten

Veerbelaste pin (enkel) voor PCB-, ICT-, FCT-testen etc;

Pogo-pin (connector) om verbinding tot stand te brengen tussen twee printplaten voor opladen, lokaliseren, batterij-, halfgeleider- en interconnect-toepassingen;

Sonde met twee uiteinden voor BGA- en halfgeleider tests;







Universele pin zonder veer, coatingpin, LM-pin met QZ- en VZ-serie;

Hoge stroomsonde, schakelaarsonde, capaciteitsnaald;

Terminal & stopcontact/aansluiting;

Andere gerelateerde elektronische componenten, 30 # OK-draad, malsloten, POM, ijzeren scharnier enz

Kwaliteitscontrole

Spring exhausted tester	DC power supply	Current resistance tester
		
Microscope	Tensile strength tester	Spring tester
		

Certificering



Quality Management System Certificate of Approval

This is to certify that the QMS of

Suzhou Shengyifurui Electronic Technology Co.,Ltd

Unified Social Credit Code:91320506MA1NRNLF6N

Registration Address:Room 5277 Tianlong Building, No.378 Zhujiang Nan Road, Mudu Town,
Wuzhong District, Suzhou City

Business Address:Room 103 Units 2 Building 4, Xiangtihuayuan, No.567 Binhe Road, SND, Suzhou City

Has been assessed and found to meet the requirements of

GB/T 19001-2016/ISO 9001:2015

This certificate is valid for the following scope of operations:

Sales of test probes and related accessories

Date of Certificate Issue: Dec, 06, 2018

Certificate Valid Until: Dec, 05, 2021

Certificate Number: **QM291812020**

The validity of the registration will be continued only when the organisation pass the annual surveillance audit.
Check the validity of certificate at www.cnca.gov.cn or www.das-china.com

Surveillance Audits:



Authorized by:

Chief Executive



Shanghai DAS Certification Co., Ltd., member of SN Registrars(Holdings) Ltd.

Add:505, Tower. 2, Guosun Center, No. 388, Zhongjiang Road, Shanghai, P.R.China, 200062
Tel: 0086-21-62773910 Fax:0086-21-62080319
Web:<http://www.das-china.com>
Email: info@das-china.com
UK Head Office:DAS Certification Limited (On Behalf of SN Registrars (Holdings) Limited)
ADD: Registration House, 22b Church Street, Rushden, Northamptonshire, NN10 9YT, UK
Tel: +44(0)1933 381859
Email: info@dascertification.co.uk
Web: www.dascertification.co.uk
Company Number: 07659067



Verpakkingsbeeld

