

Productspecificatie

Merk	SFENG
Itemnummer	670-026
Zuiger	Messing of Becu, goud of Ni plated
Vat	Messing, goud of Ni plated
Lente	SK4, muziek draad
MOQ	100st
Doorlooptijd	7 werkdagen na ontvangst van de betaling

Product Picture

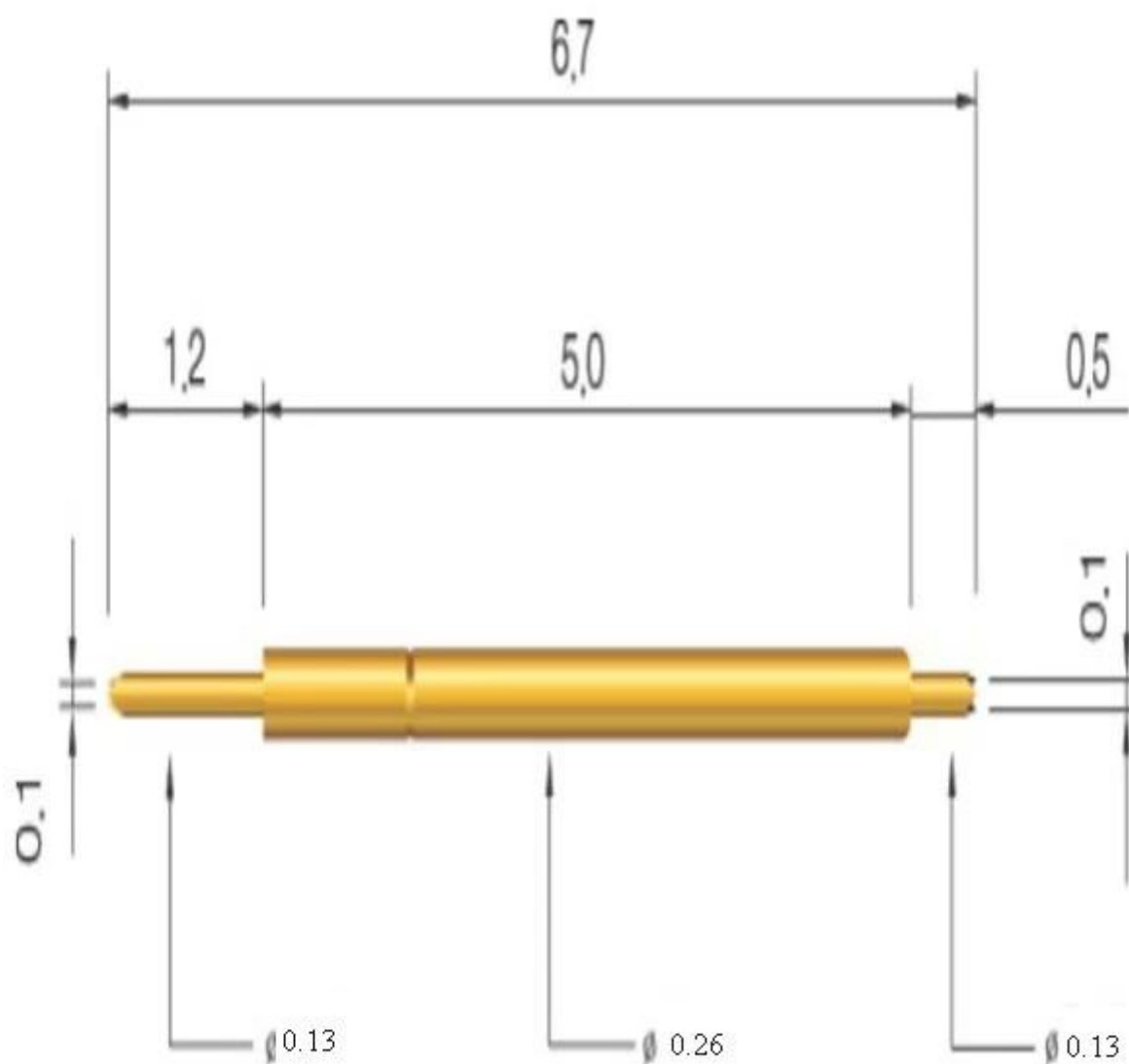

Onze Service

1. Reply uw aanvraag within 24 werkuren
2. Customized ontwerp is beschikbaar, OEM zijn welkom

3. Delivery de sonde pinnen aan onze klanten over de hele wereld met snelheid en precisie

4. Provide de laagste prijs met een hoge kwaliteit aan onze klanten

hoofd producten

-- Veer geladen pin (single) voor PCB, ICT, FCT testen, etc;

-- Pogo pin (connector) om een (usually temporary) verbinding tussen stand
twee printplaten van Charging, lokaliseren, Batterij, Semiconductor & amp;
interconnect Applications;

-- Double eindigde probe of BGA & amp; semiconductor testen;







-- Universele pin zonder veer, coating pin, LM pin with QZ & amp; VZ series;

-- Hoge stroom sonde, Switch sonde, Capaciteit naald ...

-- Terminal & amp; vergaarbak / socket;

-- Andere verwante elektronische components, 30 # OK wire, Jig sloten, POM, Ironhinge, etc

Kwaliteitscontrole

Spring exhausted tester	DC power supply	Current resistance tester
		
Microscope	Tensile strength tester	Spring tester
		

Verpakking Picture

