

Productspecificatie

Merk	SFENG
Item nummer	Eindpen SF-Pin 2,05 * 6,85 mm
Materiaal en beplating	Messing, verguld over vernikkeld.
Doorlooptijd	7 werkdagen na ontvangst van de betaling

Productfoto



terminal pin SF-Pin 2.05*6.85mm

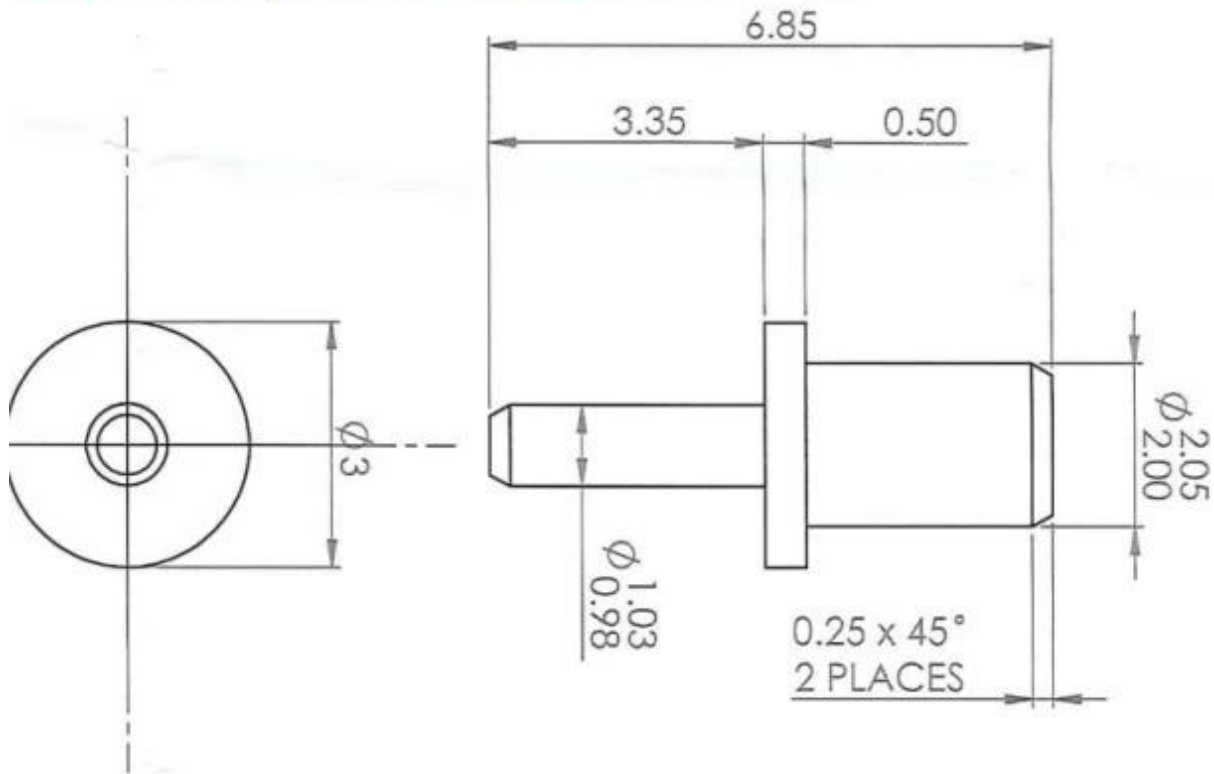

Onze service

1. We kunnen uw vraag binnen 24 werkuren beantwoorden.
2. Customizeddesign is beschikbaar en OEM zijn welkom.
3. We kunnen de probepennen leveren aan onze klanten over de hele wereld met snelheid en precisie.
4. We kunnen de laagste prijs aanbieden met een product van hoge kwaliteit aan onze klant.

hoofd producten

Veerbelaste pen (enkel) voor PCB's, ICT-, FCT-testen enz .;

Pogo-pin (connector) om verbinding tot stand te brengen tussen twee printplaten voor opladen, lokaliseren, batterij, halfgeleider & Verbind applicaties;

Sonde met dubbel uiteinde voor BGA- en halfgeleiderproeven;







Universele pin zonder veer, coating pin, LM pin met QZ en VZ-serie;

Hoogstroomsonde, Schakelaarprobe, Capaciteitsnaald;

Terminal & contactdoos / contactdoos;

Andere gerelateerde elektronische componenten, 30 # OK draad, Jig locks, POM, Iron scharnier enz

Kwaliteitscontrole

Spring exhausted tester	DC power supply	Current resistance tester
 A large, white, industrial-grade testing machine with a glass door and a control panel on the right side.	 A white, rectangular DC power supply unit with a black front panel. It features a red emergency stop button, a red power switch, and several control knobs and dials. The brand name 'YoRi' is visible on the top left.	 A white, rectangular electronic testing device with a large green digital display showing '8.8.8.8'. It has a warning symbol and a circular port on the right side.
Microscope	Tensile strength tester	Spring tester
 A white and black compound microscope with a large objective lens and a camera attachment on top.	 A blue and white tensile testing machine with a vertical column and a sample holder.	 A white and blue spring testing machine with a digital display and a control panel.

Afbeelding inpakken

