

Productspecificatie

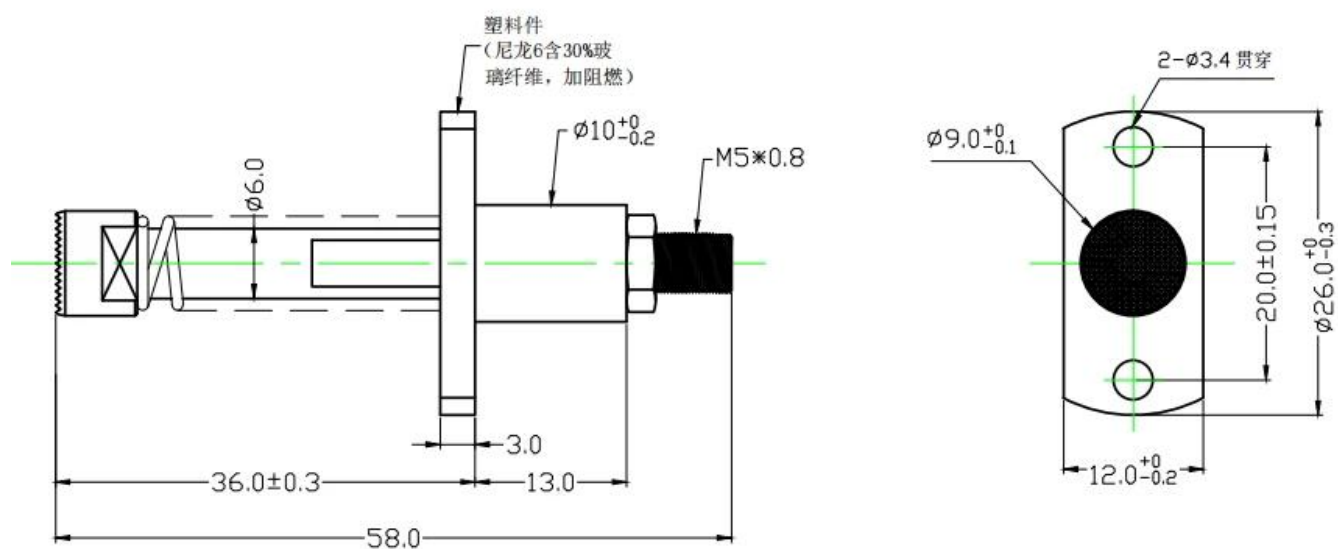

Model	SF-30A Huidige Probe Pin (9.0*58.0)
Materialen	Messing
Maat	9.0*58mm
Huidig beoordeling	30A
Lente kracht	2500g

Productfoto

SFENG
The China's The World's



chinapogopinsupplier.com

Onze service

1. We kunnen uw vraag binnen 24 werkuren beantwoorden.
2. Aangepast ontwerp is beschikbaar en OEM is welkom.
3. We kunnen de sondepennen snel en nauwkeurig aan onze klanten over de hele wereld leveren.
4. We kunnen onze klant de laagste prijs bieden met een product van hoge kwaliteit .

hoofd producten

Veerbelaste pen (enkel) voor PCB-, ICT-, FCT-testen enz.;

Pogo-pin (connector) om een verbinding tot stand te brengen tussen twee printplaten voor opladen, lokaliseren, batterij-, halfgeleider- en interconnect-toepassingen;

Dubbelzijdige sonde voor BGA- en halfgeleidertesten;

Universele pen zonder veer, coatingpen, LM-pen met QZ- en VZ-serie;

Hoge huidige sonde, Schakelaarsonde, Capaciteitsnaald;

Terminal & contactdoos / contactdoos;

Andere gerelateerde elektronische componenten, 30 # OK-draad, Jig-slots, POM, ijzeren scharnier enz

Kwaliteitscontrole







Spring exhausted tester	DC power supply	Current resistance tester
 A tall, white industrial cabinet with a glass door and a control panel on the right side.	 A white YoRi adjustable DC power supply unit with a red power switch, a digital display, and several output terminals.	 A white electronic device with a green digital display showing '8888', a warning symbol, and a control knob.
Microscope	Tensile strength tester	Spring tester
 A white and black compound microscope on a wooden table.	 A blue and white tensile strength testing machine with a vertical column and a sample holder.	 A white spring testing machine with a digital display and a control panel.

Foto inpakken



Fabrieksaafbeelding

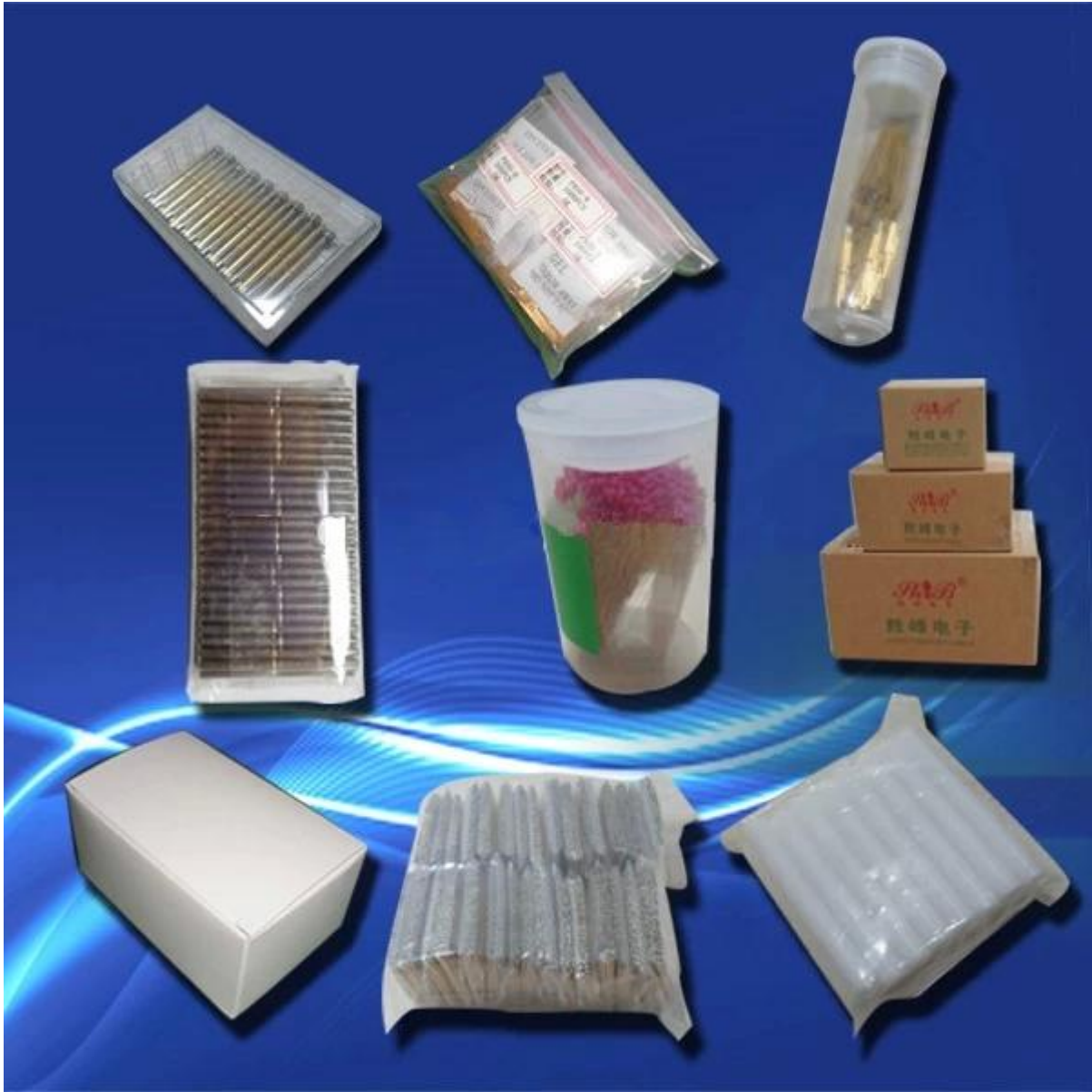