

Hoge huidige pogo pin SF-5.5 * 49mm met hoge kwaliteit

Item:	SF-high current pogo pin 5.5 * 49mm
Plunjer:	Messing, verguld over vernikkeld
Vat:	Messing, verguld over vernikkeld
De lente:	Roestvrij staal
Lente kracht:	500g / 700g / 1000g
Huidige rantsoen:	15EEN
duurzaamheid:	10000cycles tenminste

Pogo pin foto:





pogo pin tekening:

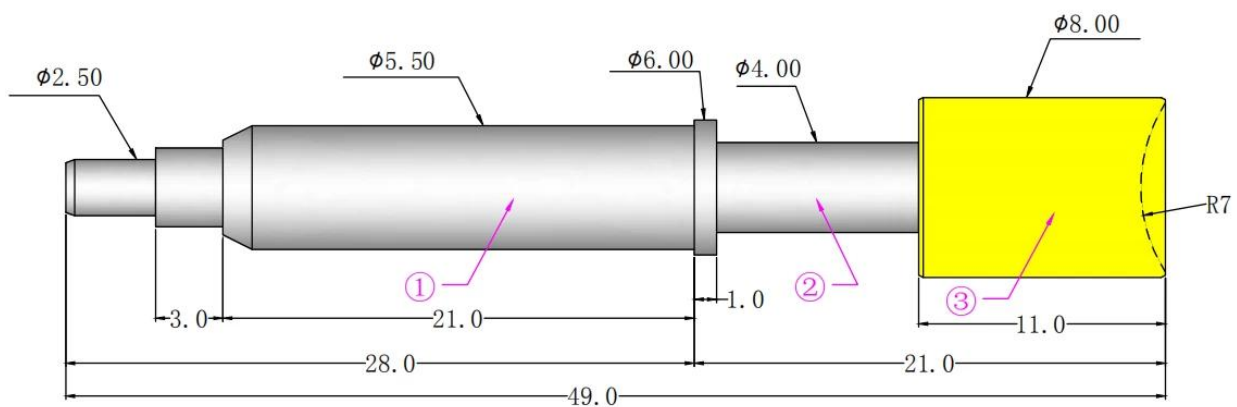

ShengFeng-probe

Ons bedrijf opgericht in 1984, Shengfeng Probe, de register naam van Suzhou Shengteng Electronic Co., Ltd, gespecialiseerd in de lente

sonde & de pogo pin & Klemmenstrook met goede kwaliteit, snelle levering en de beste service.







Onze voordelen

1. we hebben 30 jaar ervaring in sonde pin en hebben onszelf fabriek.
2. we bieden gratis monster en hebben een testen afdeling.
3. we zouden producten als uw verzoek kunnen vervaardigen.
4. we garanderen de beste prijs en goede service.

Onze fabriek



Onze apparatuur

Spring exhausted tester	DC power supply	Current resistance tester
		
Microscope	Tensile strength tester	Spring tester
		

Ons pakket

