

Productspecificatie

Artikelcode	SF-PV1-H-H
Materiaal	Plunjier: Becu Vat: Messing, PEEK Lente: SUS304
Lente kracht	550g
Aanbevolen beroerte	6,0 mm
Huidig rantsoen	30A
Weerstand	<10mΩ

Producttekening

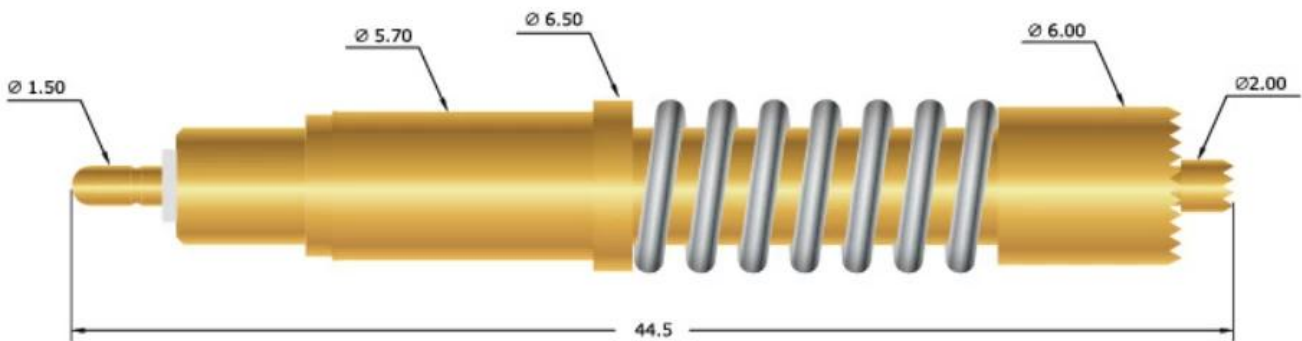

Onze service

1. Beantwoord uw vraag binnen 24 werkuren
2. Aangepast ontwerp is beschikbaar, OEM is welkom
3. Levering van de sondepinnen aan onze klanten over de hele wereld met snelheid en precisie
4. bied de laagste prijs met hoge kwaliteit aan onze klant

hoofd producten

---Veergeladen pin (enkel) voor PCB-, ICT-, FCT-testen, enz.;

---Pogo pin(connector) om een (meestal tijdelijke) verbinding tussen te maken twee printplaten voor het opladen, lokaliseren, batterij-, halfgeleider- en interconnectApplicaties;

---Het dubbel beëindigde probef orBGA; testen;







---Universele pin zonder veer, coatingpin, LM-pin met QZ- en VZ-serie;

---Hoge stroomsonde, schakelsonde, capaciteitsnaald...

---Terminal&houder/contactdoos;

---Andere gerelateerde elektronische onderdelen, 30#OKwire, Jig-slots, POM, Ironhinge, enz.

Kwaliteitscontrole

Spring exhausted tester	DC power supply	Current resistance tester
 A tall, white, industrial-grade cabinet with a glass door and a control panel on the right side.	 A white, rectangular device with a black top panel. The front panel features a red power switch, several knobs, and output terminals. The brand name 'YoRi' is visible.	 A white, rectangular device with a large green digital display showing '8888'. It has a control knob and a warning symbol on the front panel.
Microscope	Tensile strength tester	Spring tester
 A white and black compound microscope with a large objective lens and a stage.	 A blue and white mechanical testing machine with a vertical column and a sample holder.	 A white mechanical testing machine with a digital display and a control panel, used for testing springs.

Verpakkingsbeeld

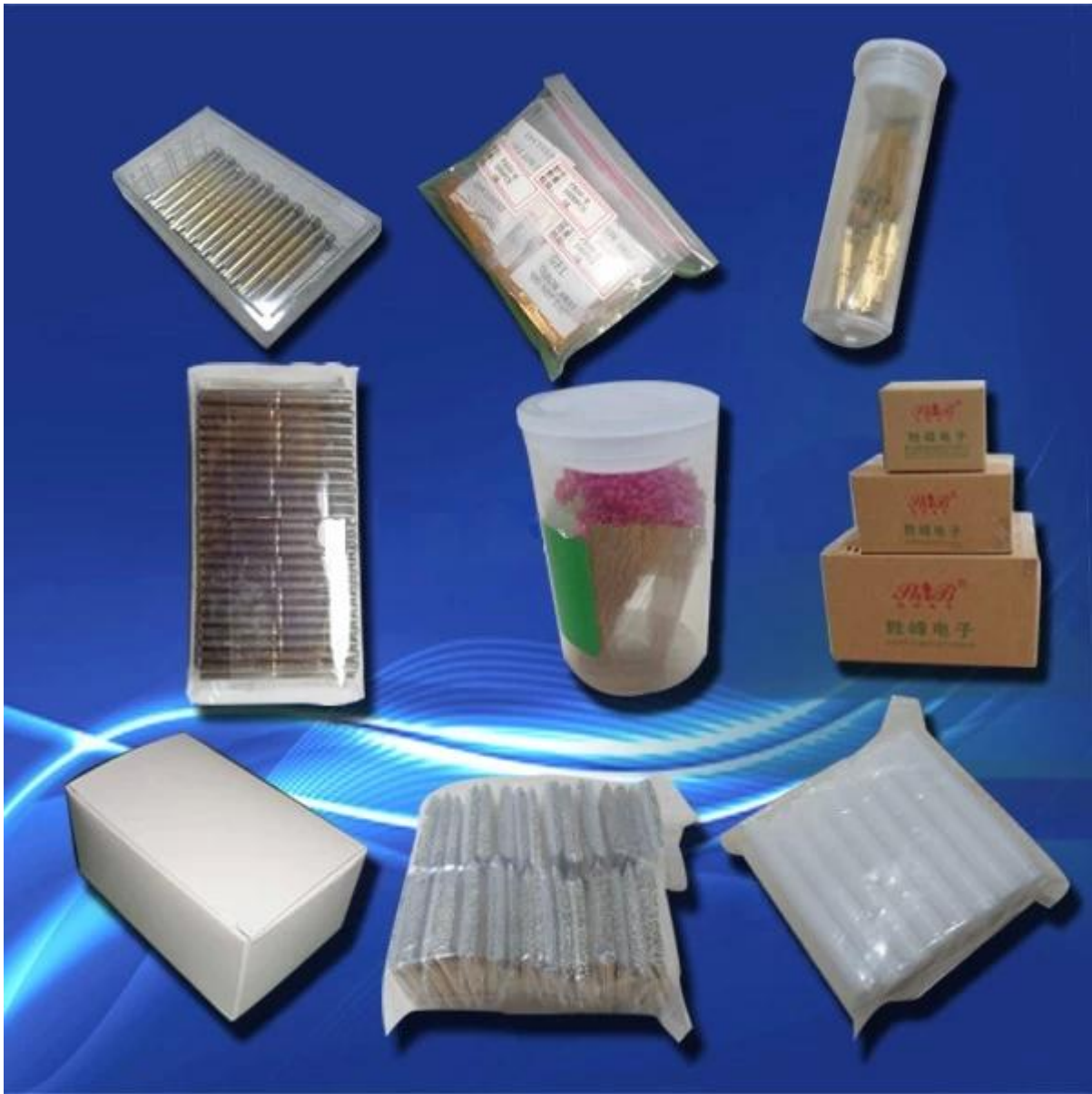

Fabrieksafbeelding

