

Productspecificatie

Merk	SFENG
Item nummer	Wissel sonde SF265-G300
Plunjer	Becu
Loop	Messing
Lente	SWP
Lente kracht	2.5N
Volledige slag	7,0 mm
Huidig rantsoen	3A
Huidige weerstand	<50mΩ
Toonhoogte	NEE
Afmeting montagegat	NEE
MOQ	100 st
Doorlooptijd	7 werkdagen na ontvangst van de betaling

Producttekening

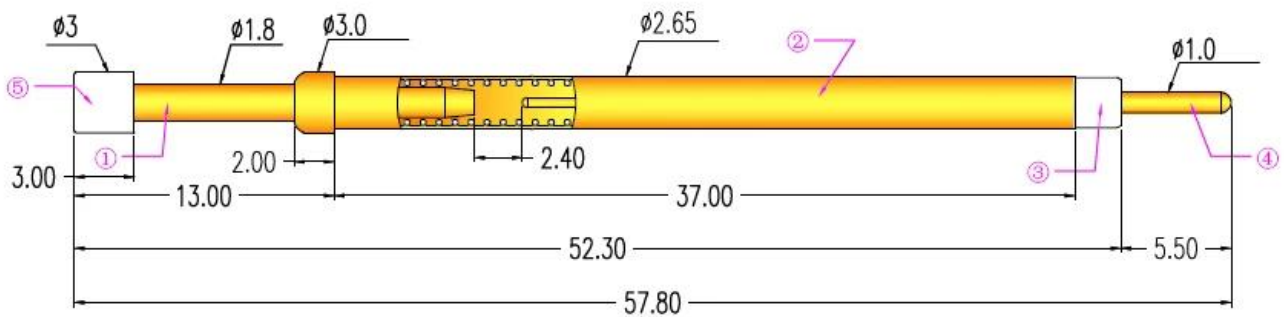

Productfoto

SFENG
The China's The World's



chinapogopinsupplier.com

Onze service

1. We kunnen uw vraag binnen 24 werkuren beantwoorden.
2. Aangepast ontwerp is beschikbaar en OEM is welkom.
3. We kunnen de sondepennen snel en nauwkeurig aan onze klanten over de hele wereld leveren.
4. We kunnen onze klant de laagste prijs bieden met een product van hoge kwaliteit.

hoofd producten

Veerbelaste pen (enkel) voor PCB-, ICT-, FCT-testen enz.;

Pogo-pin (connector) om een verbinding tot stand te brengen tussen twee printplaten voor opladen, lokaliseren, batterij-, halfgeleider- en interconnect-toepassingen;

Dubbelzijdige sonde voor BGA- en halfgeleidertesten;

Universele pen zonder veer, coatingpen, LM-pen met QZ- en VZ-serie;

Hoge huidige sonde, Schakelaarsonde, Capaciteitsnaald;

Terminal & contactdoos / contactdoos;

Andere gerelateerde elektronische componenten, 30 # OK-draad, Jig-sloten, POM, ijzeren scharnier enz

Kwaliteitscontrole







Spring exhausted tester	DC power supply	Current resistance tester
 A tall, white, industrial-grade cabinet with a glass door and a control panel on the right side.	 A white, rectangular DC power supply unit with a black front panel. It features a red power switch, several output terminals, and a digital display.	 A white, rectangular electronic device with a large green digital display showing '8888'. It has a control knob and a warning symbol.
Microscope	Tensile strength tester	Spring tester
 A white and black compound microscope with a large objective lens and a stage.	 A blue and white mechanical testing machine with a vertical column and a sample holder.	 A white mechanical testing machine with a digital display and a control panel.

Foto inpakken



Fabrieksafbeelding

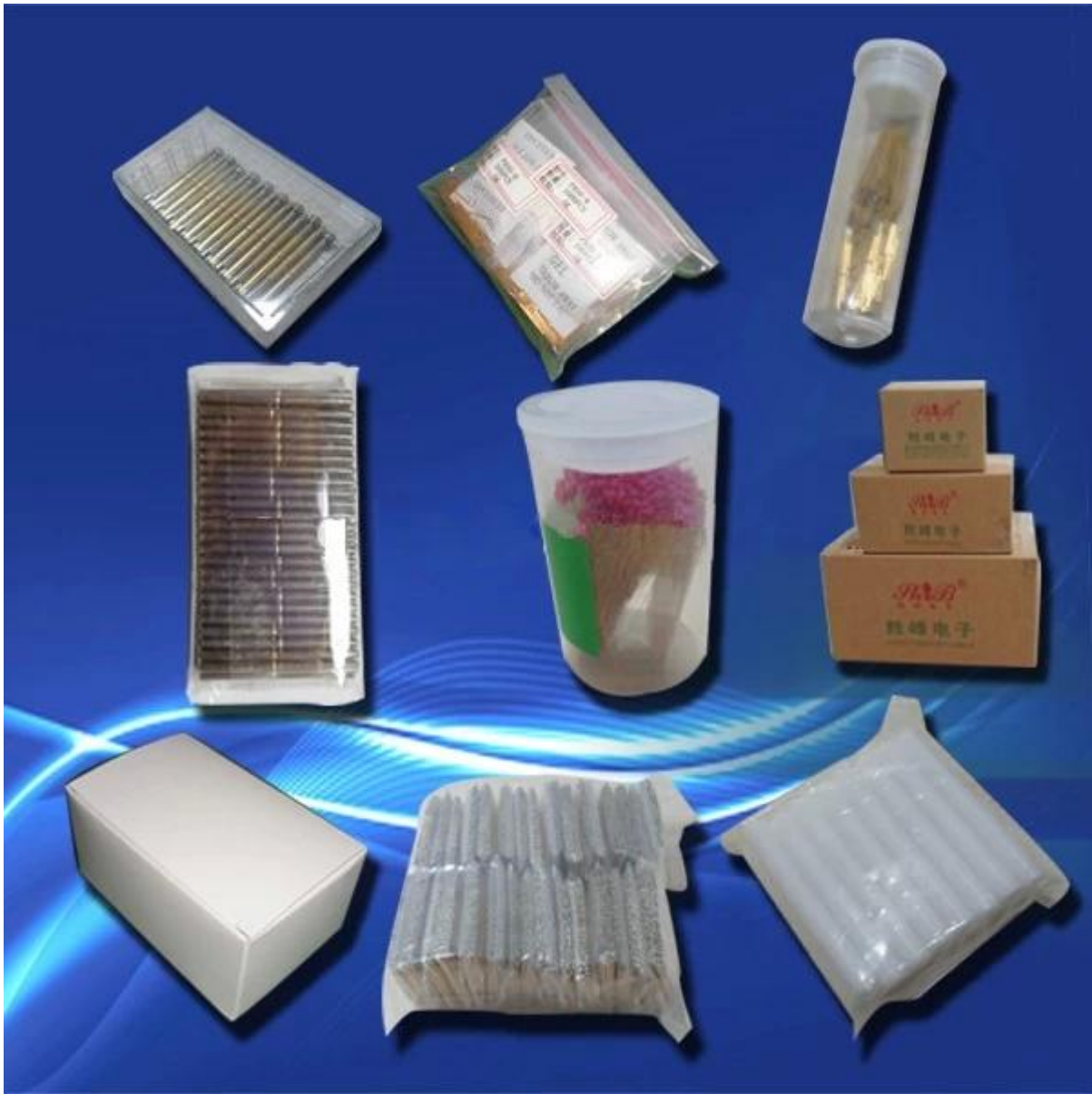