

## **Productspecificatie**

Vuur	SFENG
Item nummer	SF-PV1-HH M11*26.5
plunjer	roestvrij stang
loop	Messing
springen	roestvrij staal
springen kracht	280 g $\pm$ 20% @3,0 mm of aangepast
Huidig verhouding	50A
Huidige weerstand	gekostumeerd
Toonhoogte	Nee
grootte montagegat	Nee
MOQ	100st
doorlooptijd	7 werkdagen na ontvangst van de betaling

## **Product afbeeldingen**







***Product tekening***

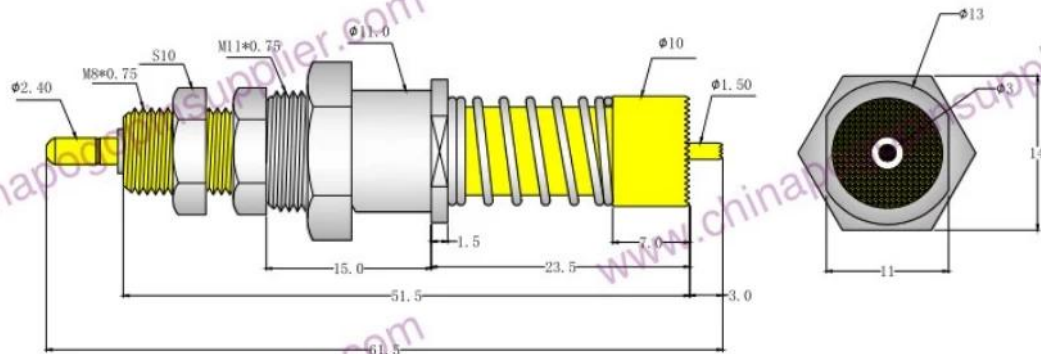

#### 技术参数

- |       |                                    |
|-------|------------------------------------|
| 1、中心针 | 镀铜/镀金                              |
| 2、大针杆 | 黄铜/镀金                              |
| 3、针套  | 黄铜/镀镍                              |
| 4、螺帽  | 黄铜/镀镍                              |
| 5、弹簧  | SUS304                             |
| 6、弹力  | 中心针 下压3.0 280-300g<br>大针杆 压平 2000g |

- |                  |            |
|------------------|------------|
| 说明: 1、所有尺寸的单位为mm |            |
| 2、未注图示尺寸公差:      |            |
| X.               | $\pm 0.1$  |
| X.X              | $\pm 0.05$ |
| X.XX             | $\pm 0.02$ |

## onze service

1. We kunnen uw vraag binnen 24 werkuren beantwoorden.
2. Aangepast ontwerp is beschikbaar en OEM is welkom.
3. We kunnen de sondepennen snel en nauwkeurig aan onze klanten over de hele wereld leveren.
4. We kunnen onze klant de laagste prijs bieden met een product van hoge kwaliteit .

## hoofd producten

springen-loaded pin (enkel) voor PCB-, ICT-, FCT-testen etc;

Pogo-pin (connector) om een verbinding tot stand te brengen tussen twee printplaten voor opladen, lokaliseren, batterij-, halfgeleider- en interconnect-toepassingen;

Dubbelzijdige sonde voor BGA- en halfgeleidertesten;







Universele pin zonder sprong, coatingpin, LM-pin met QZ- en VZ-serie;

Hoge huidige sonde, Schakelaarsonde, Capaciteitsnaald;

Terminal & contactdoos / contactdoos;

Andere gerelateerde elektronische componenten, 30 # OK-draad, Jig-sloten, POM, ijzeren scharnier enz

## Kwaliteitscontrole

Spring exhausted tester	DC power supply	Current resistance tester
		
Microscope	Tensile strength tester	Spring tester
		

***pakket***

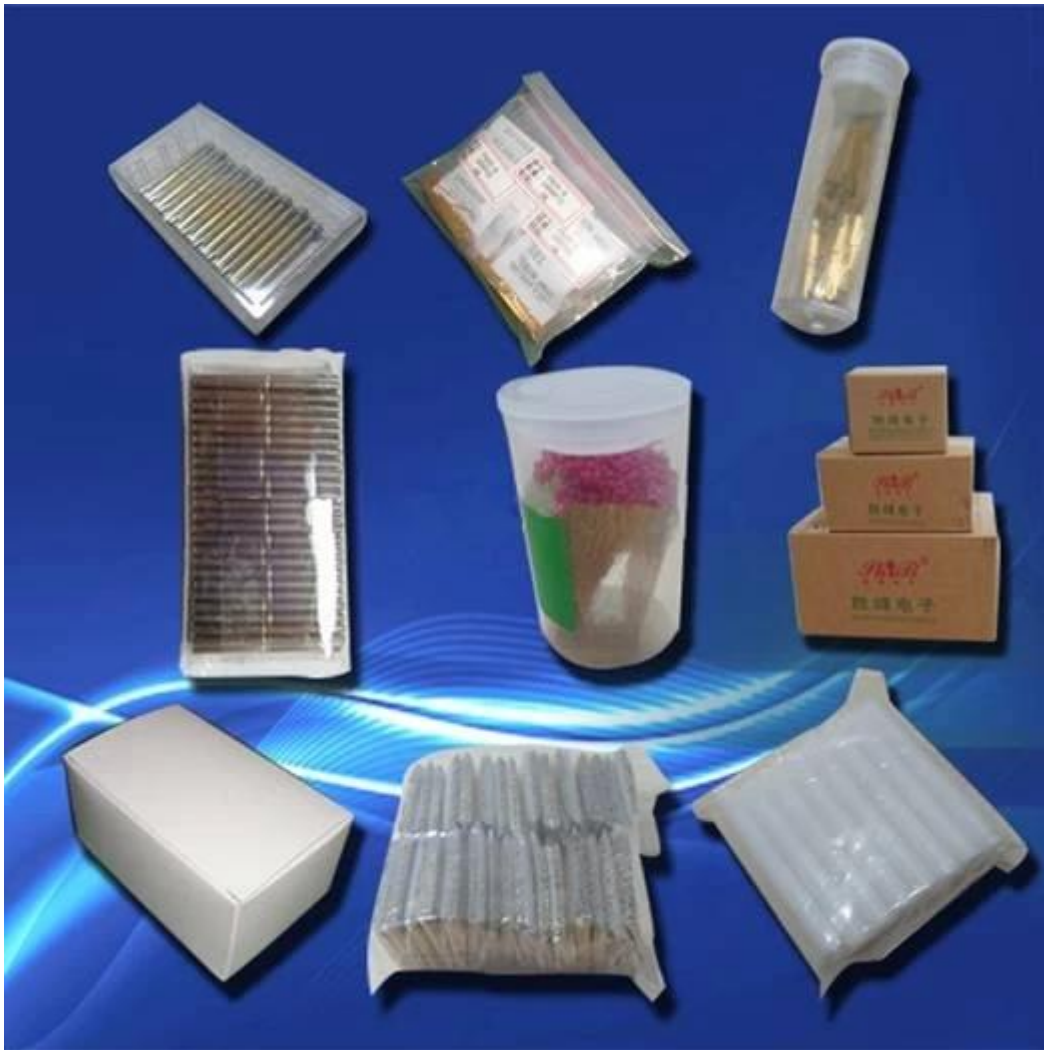

**Verzenden:**

