

Product Specification

Brand	SFENG
Item number	Terminal pin SF-Pin 2.05*6.85mm
Material and Plating	Brass, Gold-plated over nickel plated.
Lead time	7 working days after receiving the payment

Product Picture



terminal pin SF-Pin 2.05*6.85mm

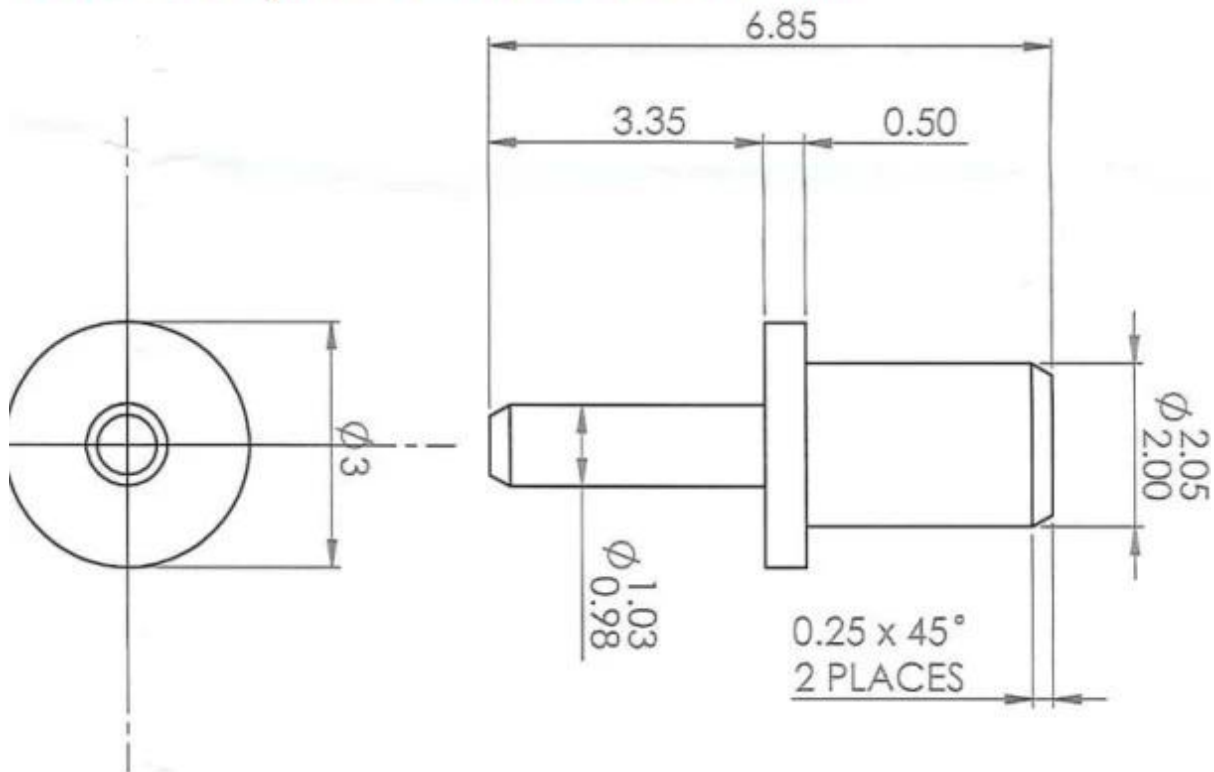

Our Service

1. We can reply your inquiry within 24 working hours.
2. Customized design is available and OEM are welcomed.
3. We can deliver the probe pins to our clients all over the world with speed and precision.
4. We can provide the lowest price with high quality product to our client .

Main Products

Spring loaded pin (single) for PCB, ICT, FCT testing etc;

Pogo pin (connector) to establish connection between two printed circuit boards for charging, locating, Battery, Semiconductor & Interconnect applications;

Double ended probe for BGA and Semiconductor testing;







Universal pin without spring, coating pin, LM pin with QZ and VZ series;

High current probe, Switch probe, Capacitance needle;

Terminal & receptacle /socket;

Other related electronic components, 30# OK wire, Jig locks, POM, Iron hinge etc

Quality Control

Spring exhausted tester	DC power supply	Current resistance tester
 A large, white, industrial-grade machine with a glass door and a control panel on the right side.	 A white, rectangular device with a black top panel. The front panel features a red power switch, several knobs, and output terminals. The text "YoRI ADJUSTABLE DC POWER SUPPLY MODEL: SP-1200-5000" is visible on the top panel.	 A white, rectangular device with a digital display showing "8.88.8". It has a warning symbol and a "VOLTAGE" label on the right side.
Microscope	Tensile strength tester	Spring tester
 A white and black compound microscope with a large objective lens and a camera attachment on top.	 A blue and white machine used for testing the tensile strength of materials, featuring a vertical column and a sample holder.	 A white and blue machine used for testing springs, with a digital display and a control panel.

Packing Picture

