

## High current pogo pin SF-5.5\*49mm with high quality

Item□	SF- high current pogo pin 5.5*49mm
Plunger:	Brass,gold plated over nickel plated
Barrel□	Brass,gold plated over nickel plated
Spring:	Stainless steel
Spring force:	500g/700g/1000g
Current ration:	15A
durability:	10000cycles at least

### Pogo pin picture:





## pogo pin drawing:

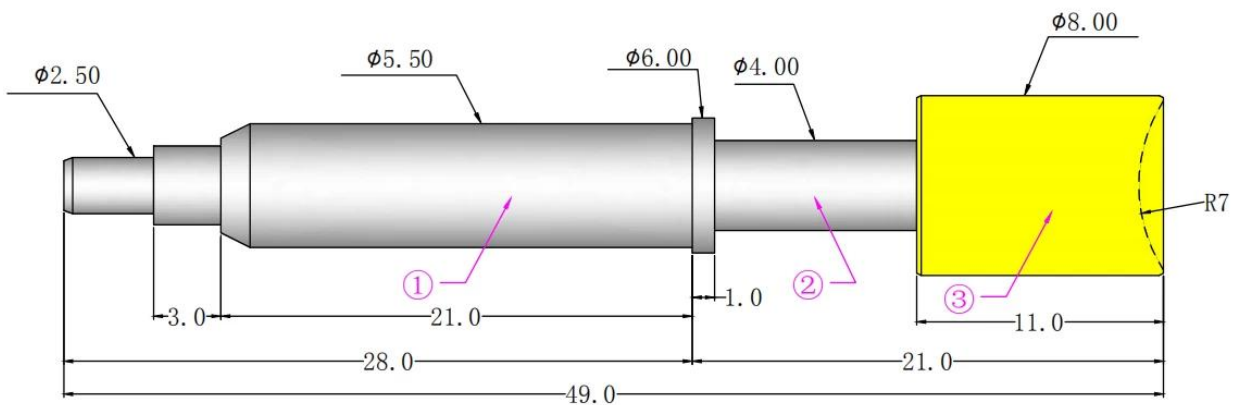

## ShengFeng Probe

Our company established in 1984, Shengfeng Probe, the register name of Suzhou Shengteng Electronic Co., Ltd, specializing in the

spring probe & the pogo pin & Terminal block with good quality, fast delivery and best service.







## Our Advantages

1. we have 30 years experience in probe pin and have ourself factory.
2. we provide free sample and have a testing department.
3. we could manufacture products as your request.
4. we guarantee best price and good service.

## Our factory



## Our equipment

Spring exhausted tester	DC power supply	Current resistance tester
		
Microscope	Tensile strength tester	Spring tester
		

Our package

