

Production specifications

Item number	SF5880
Current ration	3A
Contact Resistance	$\leq 50\text{m}\Omega$
Full travel	4.0mm
Spring force	200 \pm 20%gf@ load 4.0mm
MOQ	100PCS
Payment term	100% T/T before shippment
Delivery time	5-10days after receiving the payment

Product Pictures

SF-P160

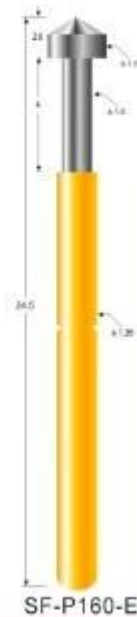
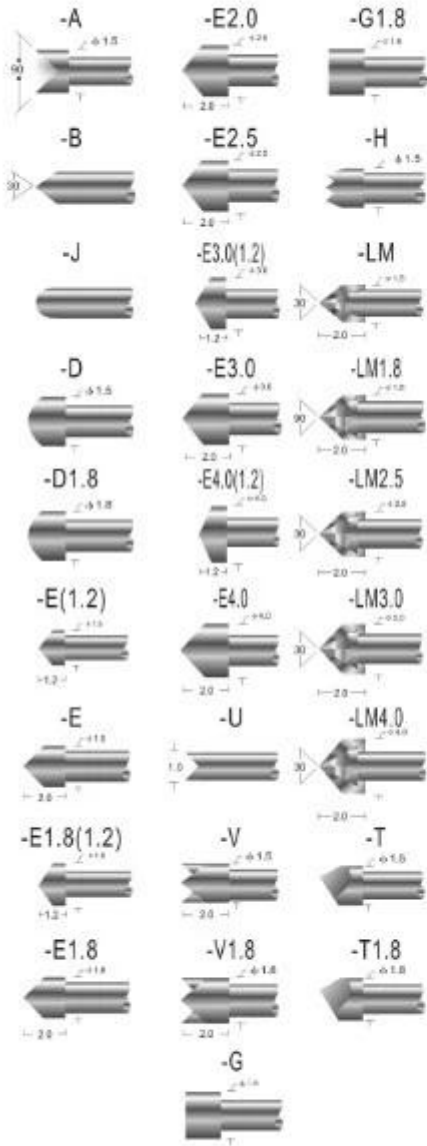

Probe specifications SF-P160(技术规格)

- Recommended minimum center(最小间距): 2.54mm(.1000 ")
- Mounting hole size(钻孔尺寸):
压克力: 1.70mm(.0670 ")
电木板、玻璃纤维板: 1.75mm(.0689 ")
- Full travel(行程): 4.0(.1575 ")
- Spring force(弹簧压力): 200g
- Materials and finishes(材料及涂饰):
Plunger: Be Cu, Rh plated; SK4, Rh plated
Barrel: Brass, Gold plated
Spring: Stainless steel
- Current ration(额定电流): 3A(安培)
- Contact resistance(接触电阻): 50mΩ (毫欧姆)

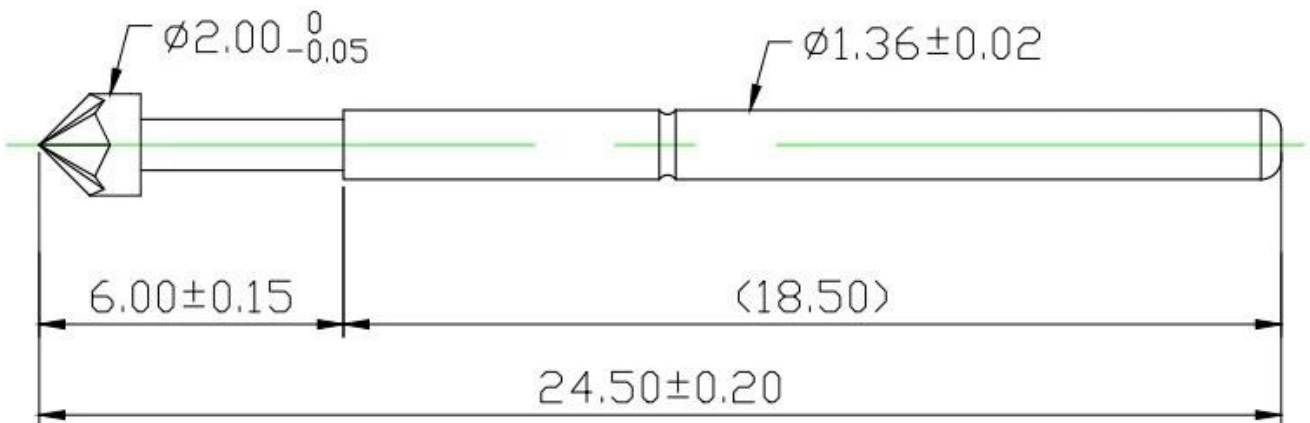

Production Flow



Production Flow (生产流程)



1. raw material warehouse



2. Lathe workshop



3. Assemble workshop



4. Quality inspection



5. Finished products



6. Packing

Testing Equipment

Measuring Equipment >

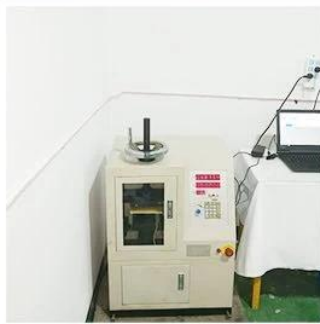
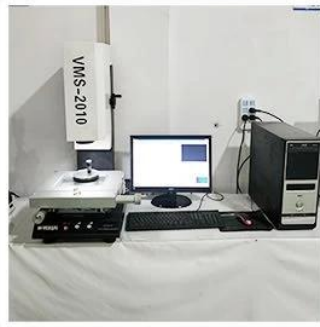
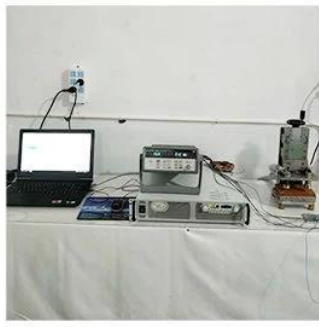

Measuring Equipment:

1. Agilent current testing;
2. Quadratic element measurement
3. Load Curve Meter
4. Bond Test
5. Life Fatigue Test

Packing



Quality Certification



Quality Management System Certificate of Approval

This is to certify that the QMS of

Suzhou Shengyifurui Electronic Technology Co.,Ltd

Unified Social Credit Code:91320506MA1NRNLF6N

Registration Address:Room 5277 Tianlong Building, No.378 Zhujiang Nan Road, Mudu Town,
Wuzhong District, Suzhou City

Business Address:Room 103 Units 2 Building 4, Xiangtihuayuan, No.567 Binhe Road, SND, Suzhou City

Has been assessed and found to meet the requirements of

GB/T 19001-2016/ISO 9001:2015

This certificate is valid for the following scope of operations:

Sales of test probes and related accessories

Date of Certificate Issue: Dec, 06, 2018

Certificate Valid Until: Dec, 05, 2021

Certificate Number: **QM291812020**

The validity of the registration will be continued only when the organisation pass the annual surveillance audit.

Check the validity of certificate at www.cnca.gov.cn or www.das-china.com

Surveillance Audits:

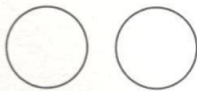

Authorized by:

Chief Executive



Shanghai DAS Certification Co., Ltd. , member of SN Registrars(Holdings) Ltd.

Add:505, Tower. 2, Guoson Center, No. 388, Zhongjiang Road, Shanghai, P.R.China, 200062

Tel: 0086-21-62773910 Fax:0086-21-62080319

Web:<http://www.das-china.com>

Email: info@das-china.com

UK Head Office: **DAS Certification Limited (On Behalf of SN Registrars (Holdings) Limited)**

ADD: Registration House, 22b Church Street, Rushden,

Northamptonshire, NN10 9YT, UK

Tel: +44(0)1933 381859

Email: info@dascertification.co.uk

Web: www.dascertification.co.uk

Company Number: 07659067



Main products

- 1.Spring loaded pin(single)for PCB,ICT,FCTtesting etc;
- 2.Pogo pin(connector)to establish connection between two printed circuit boards for charging,locating,battery,semiconductor&interconnector applications;
- 3.Double ended probes for BGA and semiconductor testing;
- 4.Universal pin without spring,coating pin,LM pin with QZ and VZ series;
- 5.High current probe,switch probe,capacitance needle;
- 6.Terminal&receptacle/socket;
- 7.Other related electronic components,Jig locks,POM and etc.

Whatever you want,please contact us without hesitation ,and we will try our best to meet your requirement within our capability.

Our service

- 1.We can reply your inquiry within 24 working hours;
- 2.Customized design is availble and OEM are welcomed;
- 3.We can deliver the probe pins to our clients all over the world with speed and precision.
- 4.We can provide the lowest price with high quality products to our clients.