

Product Specification

Brand	SFENG
Item number	SF-Pogo pin
Plating	Gold plated
Lead time	7 working days after receipt of payment

Product Image



SFENG
The China's The World's

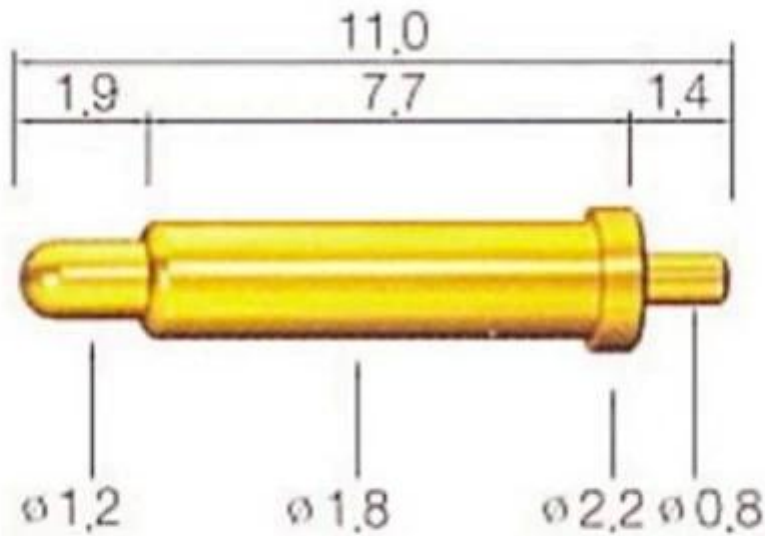

WWW.SF-PROBE.COM

Our service

1. We can answer your request within 24 hours.
2. custom Design is available and OEM are welcome.
3. We can deliver the probe pins to our customers all over the world with speed and precision.
4. We can provide the lowest price with high quality products to our customers.

main products

spring pin (single) for PCBs, ICT, FCT testing etc;

Pogo pin (connector) to establish the connection between the two circuit boards for loading, location, battery, Semiconductor & amp; amp; interconnect applications;

double ended probe for BGA and semiconductor testing;







Universal pin without spring coat pin, pin LM with QZ and VZ series;

High current probe, Switch probe needle capacitance;

Terminal & amp; amp; receptacle / plug;

Other related electronic components, wire # 30 OK, Jig locks, POM, hinge iron etc.

Quality control

Spring exhausted tester	DC power supply	Current resistance tester
		
Microscope	Tensile strength tester	Spring tester
		

Packing Photo

