

Especificação do produto

Código do item	SF-PPA1.7*7.95
Material	Barril: Latão, Au on Ni banhado Êmbolo: Latão, Au on Ni banhado Primavera: SWP
Classificação atual	3A
Curso completo	2,0 mm

Desenho do Produto

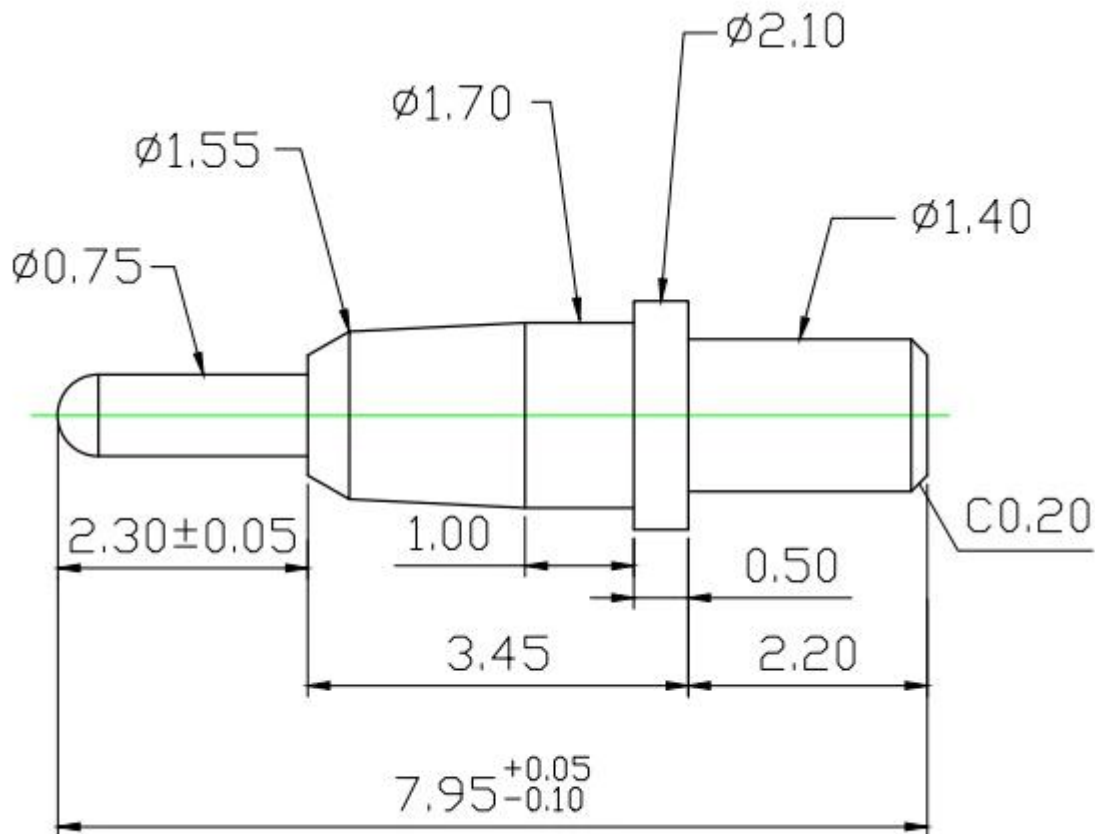

Nosso serviço

1. Podemos responder sua pergunta dentro de 24 horas úteis.
2. O design personalizado está disponível e o OEM é bem-vindo.
3. Podemos entregar os pinos da sonda para nossos clientes em todo o mundo com velocidade e precisão.
4. Podemos fornecer o preço mais baixo com produtos de alta qualidade ao nosso cliente.

Produtos Principais

Pino com mola (único) para testes de PCB, ICT, FCT, etc;

Pino Pogo (conector) para estabelecer conexão entre duas placas de circuito impresso para aplicações de carregamento, localização, bateria, semicondutores e interconexão;

Sonda dupla para testes de BGA e semicondutores;







Pino universal sem mola, pino de revestimento, pino LM com séries QZ e VZ;

Sonda de alta corrente, sonda de comutação, agulha de capacitância;

Terminal e receptáculo/soquete;

Outros componentes eletrônicos relacionados, fio 30# OK, travas Jig, POM, dobradiça de ferro etc.

Controle de qualidade

Spring exhausted tester	DC power supply	Current resistance tester
		
Microscope	Tensile strength tester	Spring tester
		

Certificação



Quality Management System Certificate of Approval

This is to certify that the QMS of

Suzhou Shengyifurui Electronic Technology Co.,Ltd

Unified Social Credit Code:91320506MA1NRNLF6N

Registration Address:Room 5277 Tianlong Building, No.378 Zhujiang Nan Road, Mudu Town,
Wuzhong District, Suzhou City

Business Address:Room 103 Units 2 Building 4, Xiangtihuayuan, No.567 Binhe Road, SND, Suzhou City

Has been assessed and found to meet the requirements of

GB/T 19001-2016/ISO 9001:2015

This certificate is valid for the following scope of operations:

Sales of test probes and related accessories

Date of Certificate Issue: Dec, 06, 2018

Certificate Valid Until: Dec, 05, 2021

Certificate Number: **QM291812020**

The validity of the registration will be continued only when the organisation pass the annual surveillance audit.
Check the validity of certificate at www.cnca.gov.cn or www.das-china.com

Surveillance Audits:

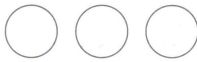

Authorized by:

Chief Executive



Shanghai DAS Certification Co., Ltd., member of SN Registrars(Holdings) Ltd.

Add:505, Tower, 2, Guosun Center, No. 388, Zhongjiang Road, Shanghai, P.R.China, 200062
Tel: 0086-21-62773910 Fax:0086-21-62080319
Web:<http://www.das-china.com>
Email: info@das-china.com
UK Head Office:DAS Certification Limited (On Behalf of SN Registrars (Holdings) Limited)
ADD: Registration House, 22b Church Street, Rushden, Northamptonshire, NN10 9YT, UK
Tel: +44(0)1933 381859
Email: info@dascertification.co.uk
Web: www.dascertification.co.uk
Company Number: 07659067



Imagem da embalagem

