

# Product Name: SF-pogo pin

## Material and finishes

**Plunger: Be Cu, Rh plated**

**Barrel: Brass, Gold plated**

**Spring: Stainless steel**

## Pictures

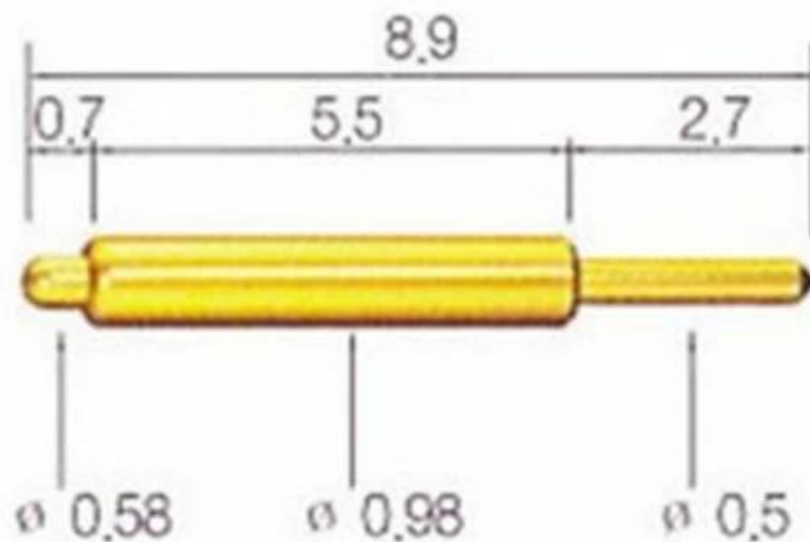

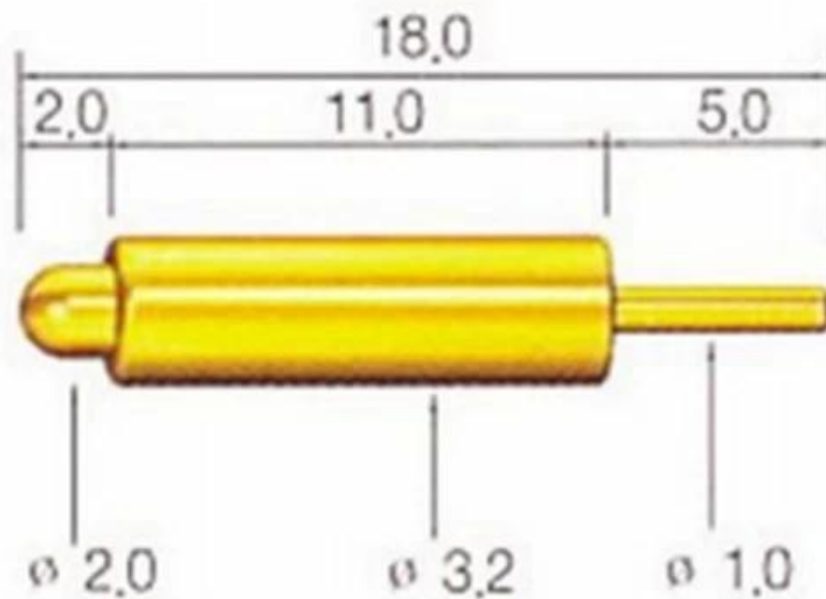

- Any tips, we could provide for you
- If you are interested in it, pls contact me

## ShengFeng Probe

**Our company established in 1984, Shengfeng Probe, the register name of Suzhou Shengteng Electronic Co., Ltd, specializing in the spring probe & the pogo pin**

**&Terminal block with good quality,fast delivery and best service.**

## **Our Advantages**

1.we have 30 years experience in probe pin and have ourself factory.

2.we provide free sample and have a testing department.







3.we could manufacture products as your request.

4.we guarantee best price and good service.

## **Our factory**



## **Our equipment**

Spring exhausted tester	DC power supply	Current resistance tester
		
Microscope	Tensile strength tester	Spring tester
		

**package**

