

Product Name:SF-pogo pin

Material and finishes

Plunger:Be Cu,Rh plated

Barrel:Brass,Gold plated

Spring:Stainless steel

Detail Pictures

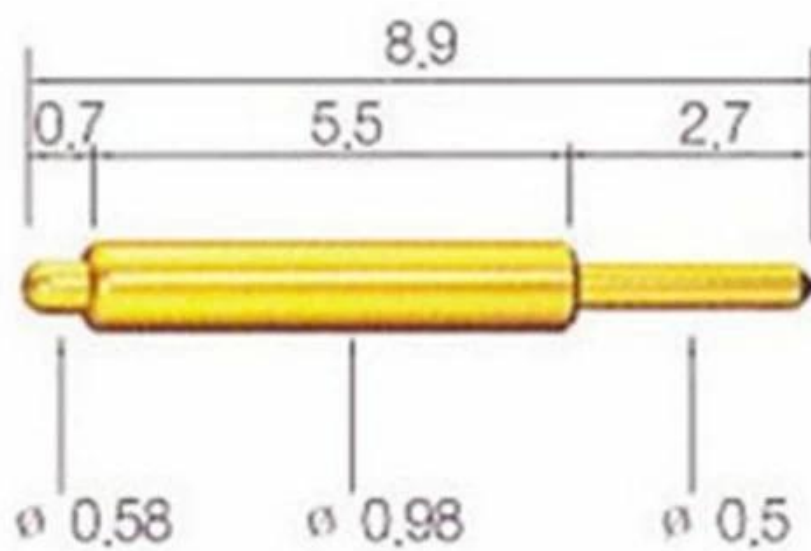

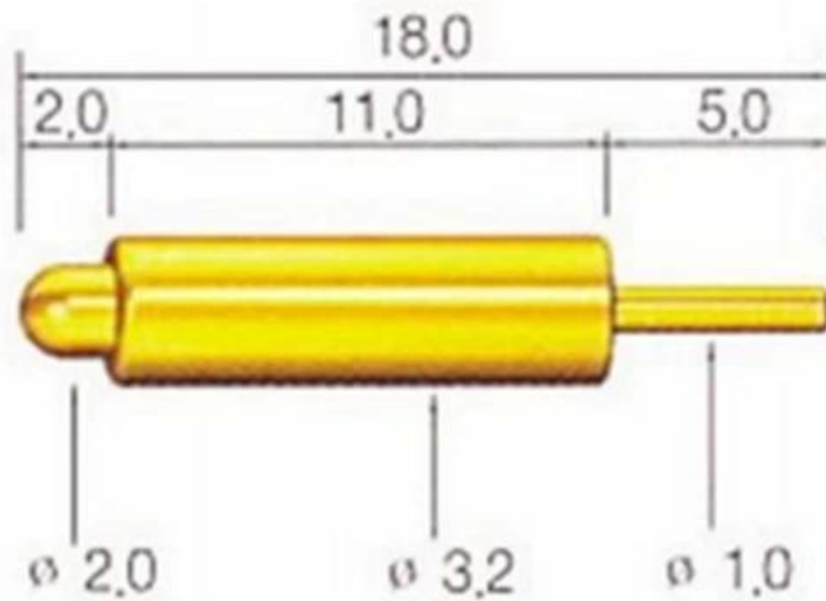

- Any tips,we could provide for you
- If you are interested in it,pls contact me

ShengFeng Probe

Our company established in 1984, Shengfeng Probe, the register name of Suzhou Shengteng Electronic Co., Ltd, specializing in the spring probe & the pogo pin & Terminal block with good quality, fast delivery and best service.





Our Advantages

1. we have 30 years experience in probe pin and have ourself factory.
2. we provide free sample and have a testing department.
3. we could manufacture products as your request.
4. we guarantee best price and good service.

Our factory



Our equipment

Spring exhausted tester	DC power supply	Current resistance tester
 A tall, white, industrial-grade machine with a glass door and a control panel on the right side.	 A white, rectangular device with a black front panel. It features a red power switch, several knobs, and output terminals. The text 'YoRi ADJUSTABLE DC POWER SUPPLY' is visible on the panel.	 A white, rectangular device with a digital display showing '8888'. It has a warning symbol and a 'STOP' button on the right side.
Microscope	Tensile strength tester	Spring tester
 A white and black compound microscope with a digital camera attachment on top, sitting on a wooden desk.	 A blue and white mechanical testing machine with a vertical column and a sample holder, positioned in a laboratory setting.	 A white mechanical testing machine with a digital display and a control panel, used for testing springs.

package

