

## Product Specification

Brand	SFENG
Item number	Coaxial probe SF-32*83.5
Plunger	Becu
Barrel	Brass
Spring	SUS304
Spring Force	4500g
Recommended stroke	6mm
Current Ration	20A
Current Resistance	□10mΩ
MOQ	100PCS
Lead time	7 working days after receiving the payment

## Product Drawings

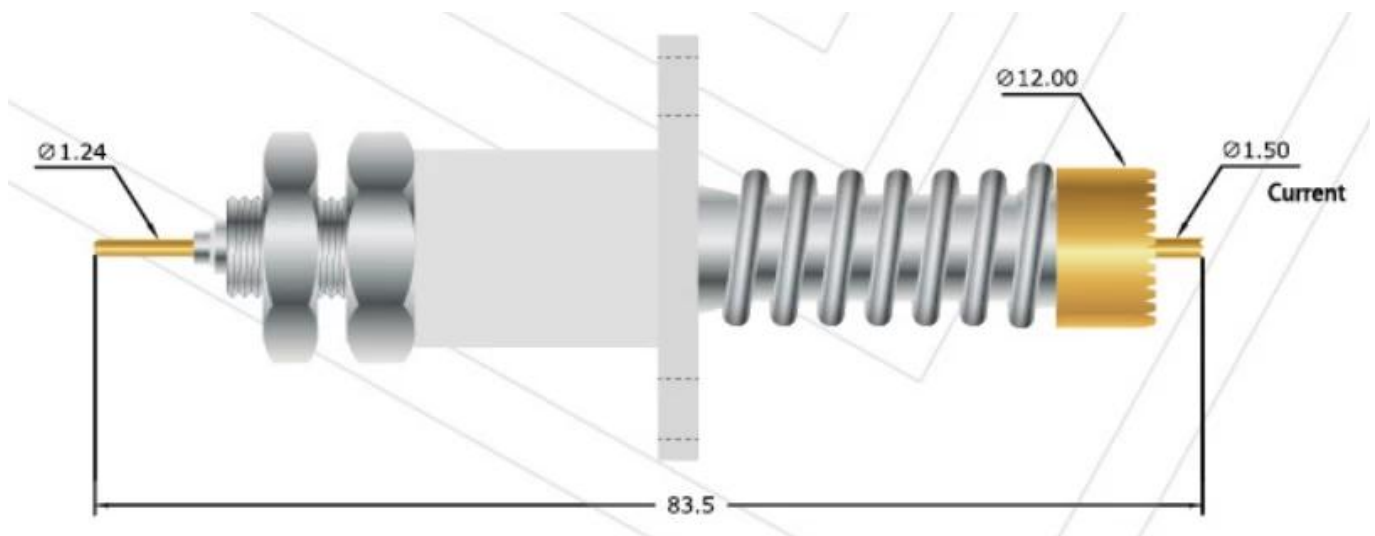

## Our Service

1. We can reply your inquiry within 24 working hours.
2. Customized design is available and OEM are welcomed.
3. We can deliver the probe pins to our clients all over the world with speed and precision.
4. We can provide the lowest price with high quality product to our client .

## Main Products

Spring loaded pin (single) for PCB, ICT, FCT testing etc;

Pogo pin (connector) to establish connection between two printed circuit boards for charging, locating, Battery, Semiconductor & Interconnect applications;

Double ended probe for BGA and Semiconductor testing;







Universal pin without spring, coating pin, LM pin with QZ and VZ series;

High current probe, Switch probe, Capacitance needle;

Terminal & receptacle /socket;

Other related electronic components, 30# OK wire, Jig locks, POM, Iron hinge etc

## Quality Control

Spring exhausted tester	DC power supply	Current resistance tester
 A tall, white, industrial-grade cabinet with a glass door and a control panel on the right side.	 A white, rectangular device with a black top panel. The front panel features a red power switch, several knobs, and output terminals. The brand name 'YoRi' and 'ADJUSTABLE DC POWER SUPPLY' are visible.	 A white, rectangular device with a large green digital display showing '8888'. It has a control knob and a power switch on the front panel.
Microscope	Tensile strength tester	Spring tester
 A white and black compound microscope with a digital camera attachment on top, mounted on a wooden desk.	 A blue and white mechanical testing machine with a vertical column and a sample holder, used for tensile testing.	 A white mechanical testing machine with a digital display and a control panel, used for testing springs.

## Packing Picture



**Factory Image**

