

Product Specification

Item Code	SF-PV1-H-H
Material	Plunger: Becu Barrel: Brass, PEEK Spring: SUS304
Spring force	550g
Recommended Stroke	6.0mm
Current Ration	30A
Resistance	□10mΩ

Product Drawing

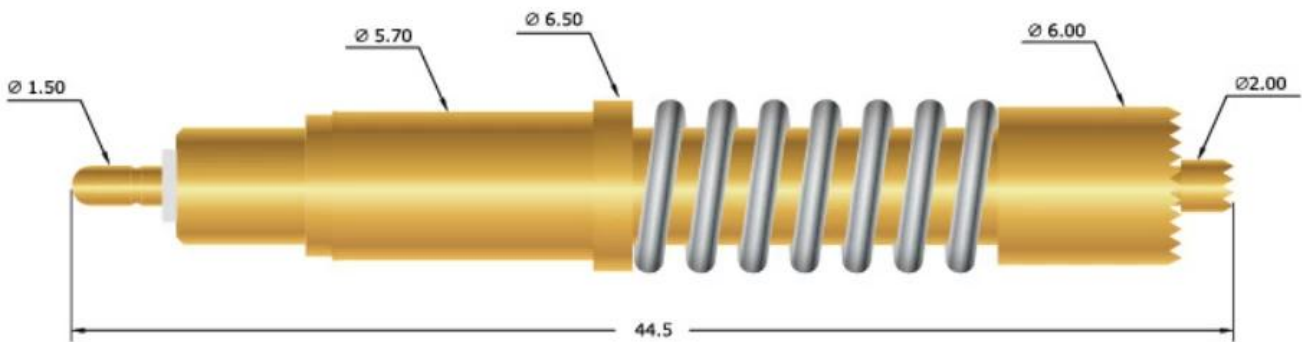

Our Service







- 1.Reply your inquiry withn 24 working hours
- 2.Customized design is available,OEM are welcomed
- 3.Delivery the probe pins to our clients all over the world with speed and precision
- 4.provide the lowest price with high quality to our client

Main Products

- Spring loaded pin(single) for PCB,ICT,FCT testing,etc;
- Pogo pin(connector) to establish a(usuallytemporary)connection between two printed circuit boards for charging, locating, Battery, Semiconductor & interconnectApplications;
- Double ended probef orBGA&semiconudtion testing;

- Universal pin without spring,coatingpin,LM pin withQZ&VZseries;
- High current probe,Switch probe,Capacitance needle...
- Terminal&receptacle/socket;
- Other related electronic compents,30#OKwire,Jig locks,POM,Ironhinge,etc

Quality Control

Spring exhausted tester	DC power supply	Current resistance tester
		
Microscope	Tensile strength tester	Spring tester
		

Packing Picture

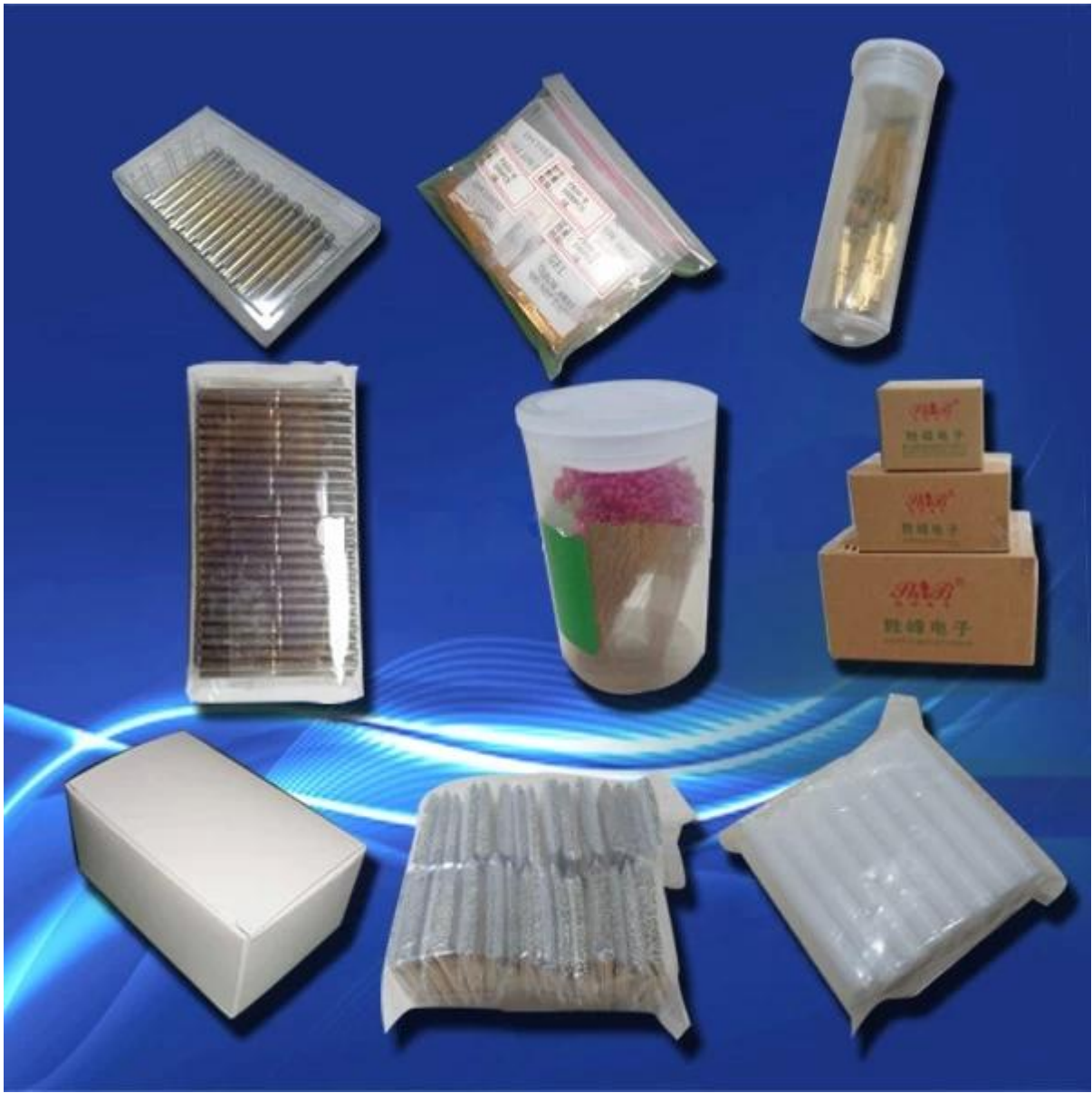

Factory Image

