

Product Specification

Brand	SFENG
Item number	Switch probe SF265-G300
Plunger	Becu
Barrel	Brass
Spring	SWP
Spring Force	2.5N
Full Stroke	7.0mm
Current Ration	3A
Current Resistance	<50mΩ
Pitch	NO
Mounting hole size	NO
MOQ	100 pcs
Lead time	7 working days after receiving the payment

Product Drawing

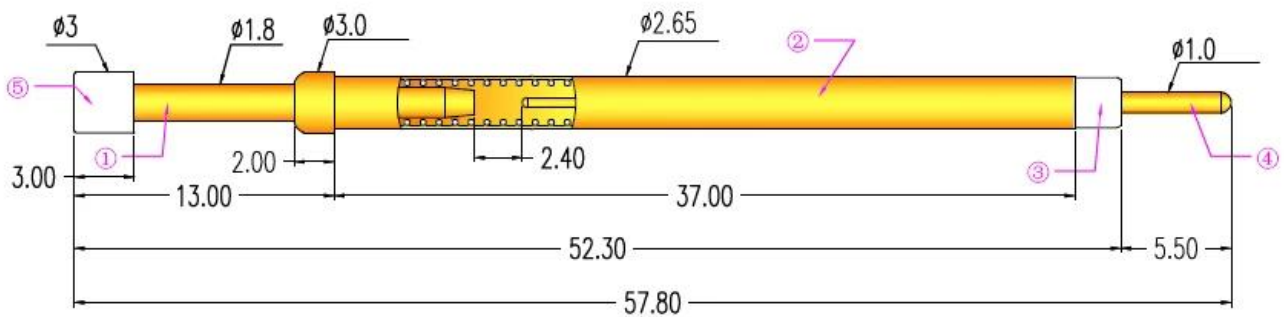

Product Picture

SFENG
The China's The World's



chinapogopinsupplier.com

Our Service

1. We can reply your inquiry within 24 working hours.
2. Customized design is available and OEM are welcomed.
3. We can deliver the probe pins to our clients all over the world with speed and precision.
4. We can provide the lowest price with high quality product to our client.

Main Products

Spring loaded pin (single) for PCB, ICT, FCT testing etc;

Pogo pin (connector) to establish connection between two printed circuit boards for charging, locating, Battery, Semiconductor & Interconnect applications;

Double ended probe for BGA and Semiconductor testing;







Universal pin without spring, coating pin, LM pin with QZ and VZ series;

High current probe, Switch probe, Capacitance needle;

Terminal & receptacle /socket;

Other related electronic components, 30# OK wire, Jig locks, POM, Iron hinge etc

Quality Control

Spring exhausted tester	DC power supply	Current resistance tester
 A large, white, industrial-grade cabinet with a glass door and a control panel on the right side.	 A white, rectangular device with a black front panel. It features a red power switch, several knobs, and a digital display. The text "YoRi ADJUSTABLE DC POWER SUPPLY" is visible on the panel.	 A white, rectangular device with a large green digital display showing "8.88.8". It has a control knob and a warning symbol on the right side.
Microscope	Tensile strength tester	Spring tester
 A white and black compound microscope with a large objective lens and a stage.	 A blue and white mechanical testing machine with a vertical column and a sample holder.	 A white and blue mechanical testing machine with a vertical column and a sample holder, similar to the tensile strength tester.

Packing Picture

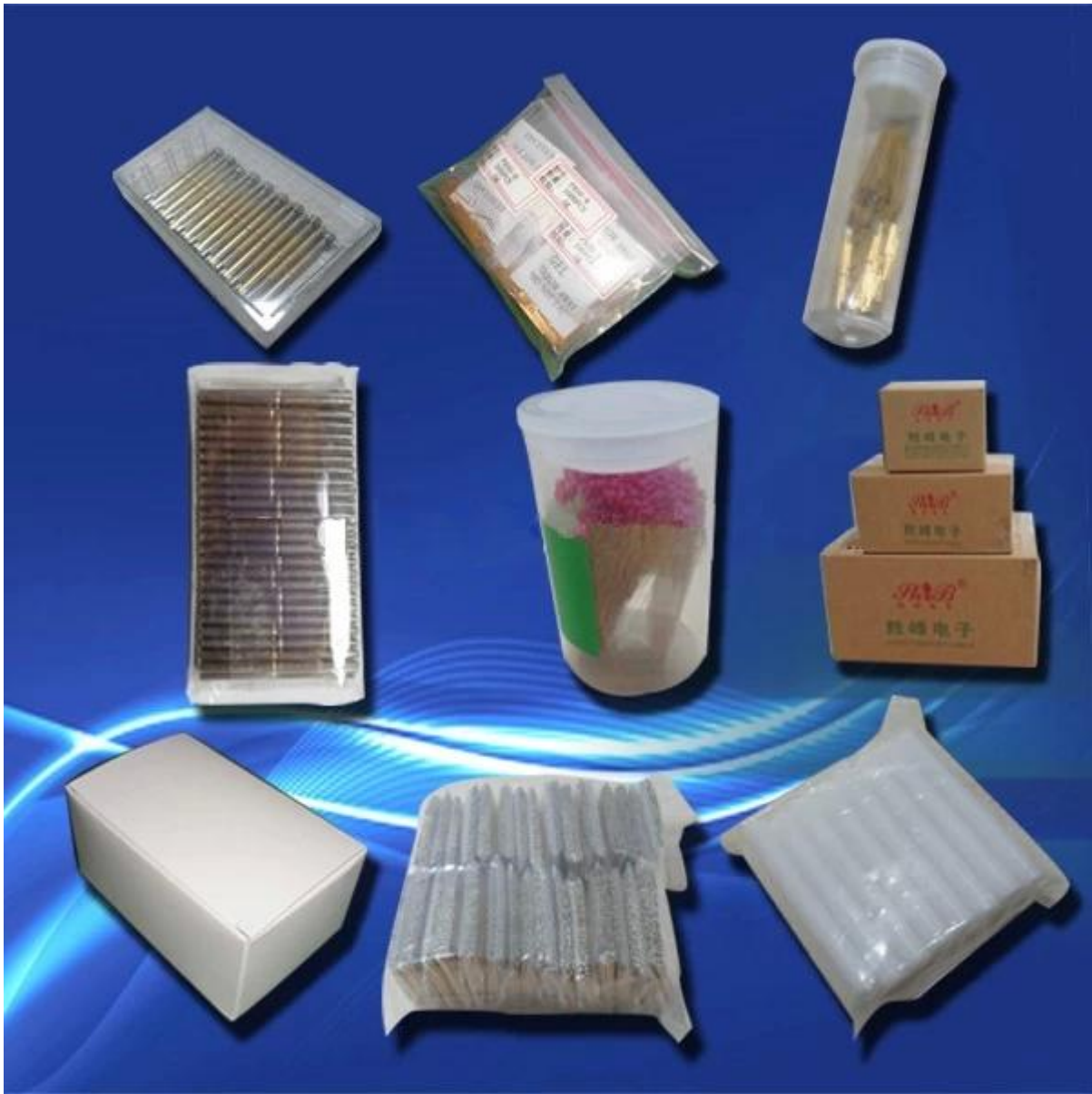

Factory Image

