

## Product Specification

Brand	SFENG
Item number	SF-PH-15
Plunger	Becu
Barrel	POM
Spring	SUS304
Spring Force	320g
Full Travel	15.0
MOQ	100

## Product Picture

SF-PH15-B3

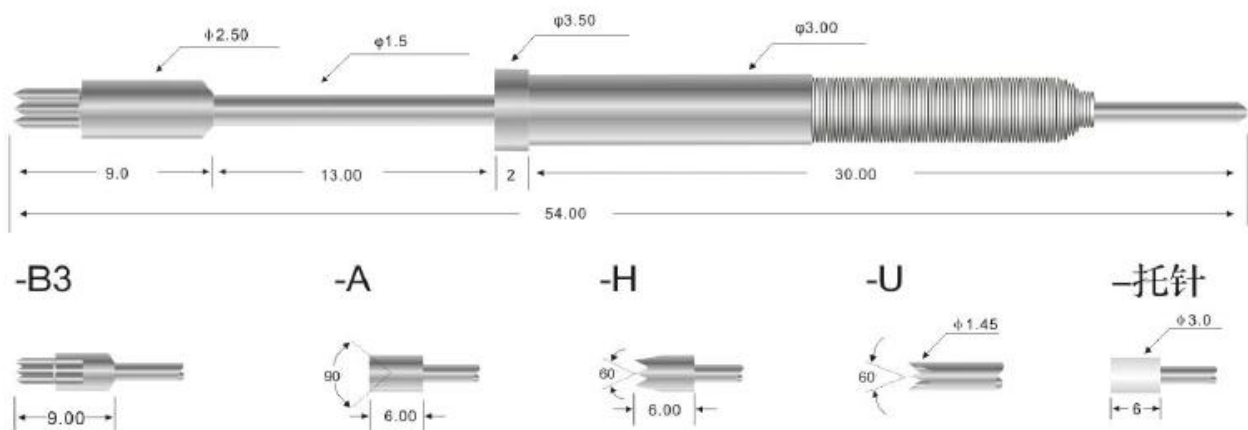

## Our Service

1. We can reply your inquiry within 24 working hours.
2. Customized design is available and OEM are welcomed.
3. We can deliver the probe pins to our clients all over the world with speed and precision.
4. We can provide the lowest price with high quality product to our client .

## Main Products

Spring loaded pin (single) for PCB, ICT, FCT testing etc;

Pogo pin (connector) to establish connection between two printed circuit boards for charging, locating, Batt ery, Semiconductor & Interconnect applications;

Double ended probe for BGA and Semiconductor testing;







Universal pin without spring, coating pin, LM pin with QZ and VZ series;

High current probe, Switch probe, Capacitance needle;

Terminal & receptacle /socket;

Other related electronic components, 30# OK wire, Jig locks, POM, Iron hinge etc

## Quality Control

Spring exhausted tester	DC power supply	Current resistance tester
		
Microscope	Tensile strength tester	Spring tester
		

## Packing Picture

